



INTRODUCTORY CATALOG

FASTENERS

HARDWARE

RIVETS & RIVET TOOLS

VEHICLE LIGHTING

ELECTRICAL

TUBING & TUBE FITTINGS

AIR BRAKE

HOSE & HOSE ENDS

CUTTING TOOLS

ABRASIVES

SAFETY

PAINT & PAINT SUPPLIES

CHEMICALS

JANITORIAL

SHOP SUPPLIES

VEHICLE & TRAILER PARTS

ASSORTMENTS

STEEL EQUIPMENT & STORAGE



Imperial Overview

Imperial has been a leading distributor of quality maintenance repair parts since 1958.

Imperial is a progressive, technologically-driven distributor of fleet maintenance products and inventory management programs. It's our mission to provide you with an efficient, effective system for ordering and stocking fleet-specific maintenance repair parts—a system that will help you keep your vehicles on the road, control your costs, reduce the hours your shop personnel spend with vendors, and improve your bottom line.

Save time and money and easily find products

Larger product selection at a lower cost. Local stores have limited shelf space meaning the product selection can be limited. Imperial stocks the widest selection of sizes, colors, brands, and products to choose from—at lower costs than conventional brick and mortar stores.

Tech specs at your fingertips. Find exactly what you need and don't settle for the product that is just close enough. Manufacturer technical specifications are readily available which makes researching your product fast and easy.

Imperial is always open. Use the Imperial Mobile App or imperialsupplies.com to place your order 24/7 without having to drive to multiple stores.

Fast shipping. Imperial has four strategically located distribution centers that can deliver your products to your shop in 2 days or less. Place your order before 1:00 CST M-F and it ships the same day.

Ordering from Imperial is quick and easy.

Download the Imperial Mobile App. Browse, search and purchase products conveniently while on the go.

Flexible ordering options. Place your order via the Imperial Mobile App, over the phone, through imperialsupplies.com or send it in by fax.

Dedicated Customer Service. An Imperial Service Advisor dedicated to your location is always there to help.



Download the Imperial app today.



Scan QR code to view the Imperial Mobile Website



The Imperial Advantage



Product Offering

Imperial carries over 25,000 fleet-specific maintenance repair parts from over 500 manufacturers world-wide.



ScanTel® Purchasing System

Imperial removes the influence of the commissioned route sales agent and provides a user-friendly, efficient way to purchase quality maintenance repair parts, where applicable.



Easy Ordering

Flexible ordering options. Visit imperialsupplies.com. Call your dedicated service advisor. Fax in your order. Submit orders using your mobile device.



Shop Conversion

A seamless transition to a more efficient parts management system. Imperial provides all the labor required to convert your shop.



Distribution Network

Innovative technology and strategically located distribution centers ensure on-time deliveries you can depend on.



Reporting

Flexible, easy-to-read reports provide important information to help you monitor purchases.



Controls

Innovative solutions that save money and put you in control of the purchasing process.



Product Programs

Customized programs designed to cut costs at the shop level.



Quality Control

Our focused quality assurance program guarantees that products satisfy SAE, IFI, DOT, OSHA and UL standards.

This page was intentionally left blank

6 Easy Ways to Order from Imperial!

1. **PHONE**

Toll-Free 1-800-558-2808

Call in your order to a Dedicated Service Advisor.

Monday - Friday, 6:00 a.m. - 7:00 p.m. CST.

2. **IMPERIAL WEBSITE**

www.imperialsupplies.com

Order online at imperialsupplies.com. View new products, hot sellers, and MSDS. Check out our entire full-line catalog online.

3. **IMPERIAL MOBILE SOLUTION**

Mobile App / Mobile Website

Search, browse, and purchase products on your mobile device conveniently while on the go. To download the app, visit the App Store or Google Play.



4. **BARCODE SCANNING**

Imperial's ScanTel® Scanning Program

Imperial's ScanTel is a fully automated purchasing system. ScanTel's advanced technology allows you to scan barcode labels and transmit your entire order via telephone or the web, day or night, seven days a week. We have a special toll-free phone number for our ScanTel customers, 1-800-SCANTEL (1-800-722-6835).

Please contact your Dedicated Service Adviser for more information.

5. **FAX**

Toll-Free 1-800-553-8769

6. **MAIL** your order to:

Imperial Supplies LLC

P.O. Box 11008, Green Bay, WI 54307-1008

Terms of Sale



PAYMENT TERMS: 1/2% - 10, Net 30 Days

MINIMUM ORDER: \$50.00

PRICES: Prices are subject to change without notice. All prices quoted at time of order will be guaranteed through time of delivery.

HOURS: 6:00 a.m. - 7:00 p.m. CST, Monday - Friday.

SHIPPING: All orders received by 1:00 p.m. CST are shipped the same day (later orders within 24 hours).

CREDIT RETURN: Returned merchandise requires a "Return Material Authorization" number (RMA number) assigned prior to return shipment. This RMA number is your confirmation of credit to follow. The credit memorandum will apply to current or future purchases.

CALL MONITORING: To insure Imperial's high standard of customer service our sales calls are randomly recorded and monitored.

Thank You!

Customer satisfaction has been a priority with us since 1958. Our relationship with customers, both new and old, is truly a priority. On a continuous basis, we evaluate products and prices to fulfill the needs of our customers.

As our customer, it is with your support that Imperial has succeeded for more than 55 years. We are committed to you as our partner in business.

Your order is truly appreciated.

Sincerely,
Imperial Associates

PLEASE NOTE: Photographs and diagrams used in this catalog are intended to represent our products as closely as possible. However, due to changes in manufacture, Imperial cannot guarantee that products shipped will exactly match all details of the photo or diagram pictured in the catalog. All products, however, will conform to Imperial specifications, which meet or exceed IFI, SAE, ICC, DOT, or UL standards.

Fasteners	6-7
Hardware	8
Rivets & Rivet Tools.....	9
Vehicle Lighting	10-11
Electrical	12-15
Tubing & Tube Fittings.....	16-17
Air Brake	18-19
Hose & Hose Ends.....	20-21
Cutting Tools	22-23
Abrasives	24-25
Safety	26-27
Paints & Paint Supplies	28-29
Chemicals	30-32
Janitorial	33
Shop Supplies	34-35
Vehicle & Trailer Parts	36-37
Assortments.....	38-40
Steel Equipment & Storage	41

Fasteners

BOLTS

HEX HEAD CAP SCREWS

- Grade 8 Hex Head Cap Screws
- Grade 5 Hex Head Cap Screws
- Grade 5 Tap Bolts
- 10.9 Metric Hex Head Cap Screws
- 8.8 Metric Hex Head Cap Screws
- 316 Stainless Steel Hex Head Cap Screws
- 18-304 Stainless Steel Hex Head Cap Screws

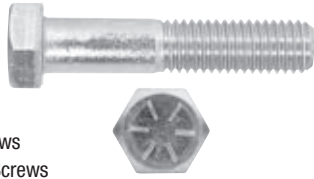

FLANGE BOLTS

- Hex Washer Head High Strength Flange Bolts
- 12 Point Head Flange Bolts
- Hex Washer Head Flange Bolts
- Hex Serrated Washer Head Flange Bolts
- 10.9 Metric Flange Bolts
- 9.8 Metric Flange Bolts

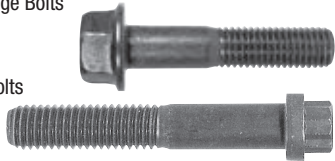

CARRIAGE BOLTS

- Square Neck Carriage Bolts
- Grade 5 Square Neck Carriage Bolts
- Grade 5 Ribbed Neck Carriage Bolts
- Shaker Screen Carriage Bolts
- 18/8-304 Stainless Steel Carriage Bolts

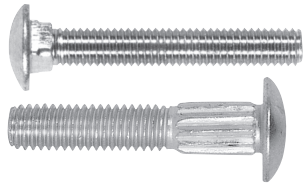

THREADED ROD

- Fractional Threaded Rod
- Stainless Steel Threaded Rod
- Metric Threaded Rod



SPECIALTY BOLTS

- Step Bolts
- U-bolts
- Elevator Bolts
- Plow Bolts
- Eye Bolts
- Center Bolts
- J-bolts



**Fastener assortments available.
See page 38 for details.**

NUTS

HEX NUTS

- Grade 8 Hex Nuts
- Grade 5 Hex Nuts
- Metric Hex Nuts
- Metric 8.8 Hex Nuts
- Metric 18/8 Stainless Steel Hex Nuts
- 18/8-304 Stainless Steel Machine Screws
- 18/8-304 Stainless Steel Hex Nuts
- 316 Stainless Steel Hex Nuts
- Heavy Hex Nuts
- High Nuts
- Large Hex Nuts



FLANGE NUTS

- Flange Lock Nuts
- Flange Nuts
- Metric Flange Lock Nuts
- Metric Flange Nuts



LOCK NUTS

- Grade 8 Lock Nuts
- Grade 8 Nylon Insert Lock Nuts
- Grade 5 Lock Nuts
- Grade C Lock Nuts
- Grade 2 Lock Nuts
- Metric 18/8 Class 10 Lock Nuts
- Metric 18/8 Stainless Steel Nylon Insert Lock Nuts
- Metric Class 10 Nylon Insert Lock Nuts
- Metric Class 8.8 Nylon Lock Nuts
- 18/8 Stainless Steel Nylon Insert Lock Nuts
- Nylon Insert Jam Nuts
- Nylon Insert Lock Nuts
- Prevailing Torque Lock Nuts
- Two-Way Lock Nuts



SPECIALTY NUTS

- Acorn Nuts
- Anti-theft Nuts
- Cage Nuts
- Coupling Nuts
- Jack Nuts
- License Plate Nuts
- Nylon Nuts
- Sleeve Nuts
- Speed Nuts
- Square Nuts
- T-nuts
- Wing Nuts



WASHERS

FENDER WASHERS

- 18/8 Stainless Steel Fender Washers
- Thick Fender Washers
- Thin Fender Washers



FLAT WASHERS

- Alloy Flat Washers
- Metric 10.9 Flat Washers
- F436 Structural
- Extra Thick



LOCK WASHERS

- Hi-Collar Split Lock Washers
- Split Lock Washers
- Star Washers
- 410 SS Star Washers



SPECIALTY WASHERS

- Machinery Bushings
- Nylon Washers
- Rib Spring Washers
- Rivet Back-Up Washers
- Sealing Washers
- Structural Washers
- Trim Washers



SCREWS

SET SCREWS

- Metric or Fractional
- Stainless Steel Available



THREAD CUTTING SCREWS

- Phillips Drive
- Slotted Drive
- Hex Washer Head



SOCKET CAP SCREWS

- Socket Head Cap Screws
 - » Button Head or Flat Head available
- Shoulder Socket Head Cap Screws

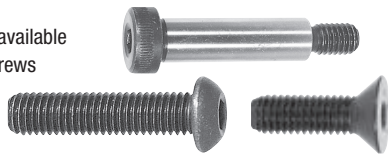

FLOORBOARD SCREWS THREAD CUTTING POINT

- Star Drive
- Countersunk or Pan Head



SHEET METAL SCREWS

- Head Styles
 - » Pan, Flat, Oval, Truss, and Hex Washer
- Drive Types:
 - » Phillips, Slotted, 6-Lobe, Square, and Hex Drive

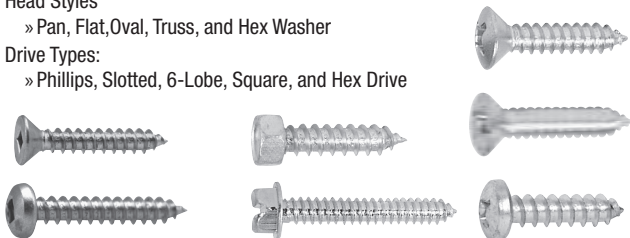

TRIM SCREWS

- With Flush, Countersunk, Washer Head and other Washers.
- Multiple Drive Styles.
- Multiple Self-Driving Point Styles

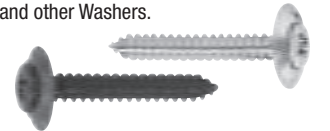

MACHINE SCREWS

- Head Styles:
 - » Pan, Flat, Truss, and Hex Head.
- Drive Types:
 - » Phillips, Slotted, Square and 6-Lobe Drive.

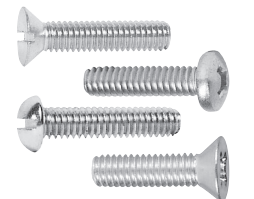

SELF DRILLING SCREWS

- Drive Types: Phillips, Slotted, Square, and Star
- Metric or Fractional
- Stainless Steel Available



OTHER SCREWS

- Drywall Screws
- Wood Screws
- Lag Screws
- Anti-Theft Screws



Hardware

CLAMPS & CLIPS

- Worm Drive Hose Clamps
 - » All Stainless Steel
 - » Lined
 - » Miniature
 - » Hi-Torque
 - » Euro Style
- Ear Clamps
- T-bolt Clamps
- Constant Torque Clamps
- Center Punch
- Tension Clamps
- Shrink Clamps
- Fuel Line Clamps
- Gates® Powergrip Clamps
- Tube Clamps
- Adhesive Clips
- Frame Clips
- Tube Clips
- Steel Clip with Rubber Cushion

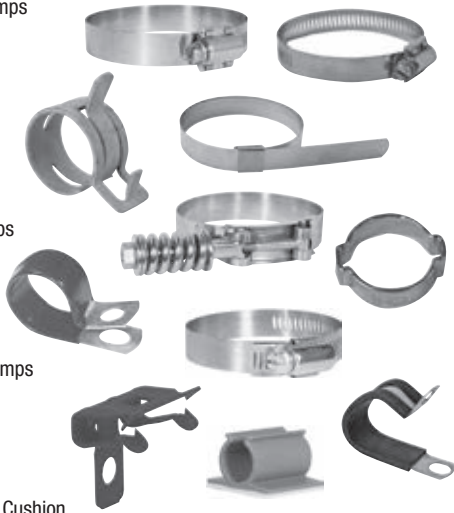

THREAD INSERTS

- Nut Inserts
- Key Locking Inserts
- Thread Repair Inserts
- Replacement Inserts
- Thread Repair Kits
- Rivet Nuts
- Timeserts

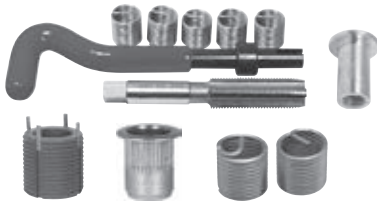

RETAINING RINGS

- Internal Snap Rings
- External Snap Rings
- E-clip Rings
- X-Washer Retainers



KEYSTOCK

- Woodruff Keys
- Plated Key Stock
- Unplated Key Stock
- Metric Key Stock
- Pin Key Stock

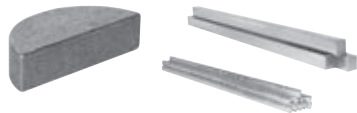

O-RINGS

- Buna-N
- Viton
- Air Conditioning
- Quad



SNAP BOLTS & HOOKS

- Snap Bolts
- Safety Snap Bolts



PINS

- Clevis Pins
- Yoke Ends
- Cotter Pins
- Hairpin Clips
- Hairpin Cotter Pins
- Hitch Pins
- Snapper Pins
- Lynch Pins
- Safety Pins
- Roll Pins
- Grooved Pins
- Dowel Pins

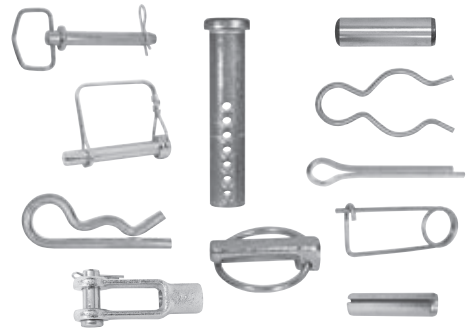

SPRINGS

- Extension Springs
- Compression Springs
- Heavy-Duty Cable Springs
- Universal Springs
- Throttle Springs

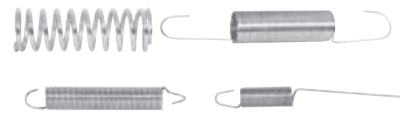

CHAIN & CHAIN ACCESSORIES

- Chains
 - » Grade 80
 - » Grade 40
 - » Grade 70 Transport
 - » Grade 30
- Chain Connectors
- Anchor Shackles
- Clevis Hooks
- Links
- Kuplers
- Roller Chains

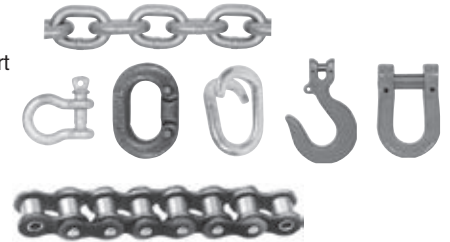

CABLE & CABLE ACCESSORIES

- Aircraft Cable
- Cable Accessories
- Cable Cutters & Crimpers



ANCHORS

- Wedge Anchors
- Drive Anchors
- Expansion Anchors
- Drop-In Anchors
- Sleeve Anchors
- Lead Anchors
- Hollow Wall Anchors
- Toggle Bolts



Rivets & Rivet Tools

BLIND RIVETS

- Buttonhead Blind Rivets
- Large Flange Blind Rivets
- Large Flange Bulb Blind Rivets
- Countersunk Blind Rivets
- Closed End Blind Rivets
- Closed End Countersunk Blind Rivets
- Multi-Range Blind Rivets
- Gespia® Bulb-Tite Blind Rivets
- Gespia® Bulb-Tite Shaveable Blind Rivets
- Peel Style T Blind Rivets
- Q-Style Blind Rivets
- Tri-Fold Blind Rivets

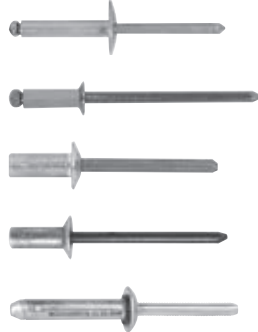

SEMI-TUBULAR RIVETS

- Door Panel Rivets
- Semi-Tubular Rivet Set



DRIVE RIVETS

- Nylon Drive Rivets
- Brazier Head Drive Rivets
- Trailer Liner Head Drive Rivets

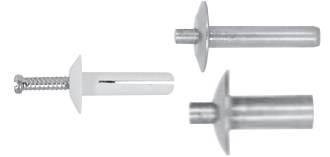

STRUCTURAL RIVETS

- Klamp-Tite Rivets
- ImperialBolt® Rivets
- Huck® Magna-Lok®
- Huck® Magna-Bulb®

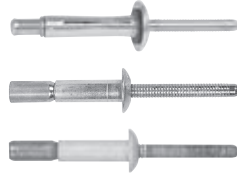

SOLID RIVETS

- Full Brazier Head Solid Aluminum Rivets
- Modified Brazier Head Solid Aluminum Rivets
- Universal Head Solid Aluminum Rivets
- Round Head Solid Aluminum Rivets
- 78° Countersunk Oval Head Aluminum Rivets



PIN & COLLAR RIVETS

- Huck® Magna-Grip®
- Huck® Magna-Grip® Collars
- Huck® Pin & Collar Rivets
- C6LB Lockbolts

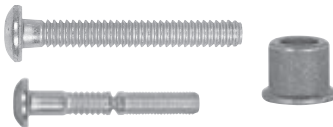

PANEL FASTENERS

- Hucktainer® Panel Fasteners
- Fiberglass Reinforced Panel Bolts (FRP Bolts)
- Fiberglass Reinforced Panel Nuts

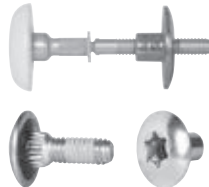

RIVET TOOLS

- Battery Powered Riveters
- Pneumatic Riveters
- Hand Rivet Tools
- Brands Include:
 - » Cherry®
 - » Gesipa®
 - » Marson®
 - » Rockford®



For technical product charts and other Imperial literature, visit imperialsupplies.com and click the 'resources tab' at the top of the webpage.

Vehicle Lighting



IMPERIAL® VEHICLE LIGHTING

- Description:
 - » Meets FMVSS 108 Federal Lighting Standards.
 - » Polycarbonate water tight construction.
- Lamp Styles:
 - » LED
 - » Incandescent
- Lamp Types:
 - » Stop/Turn/Tail Lamps
 - » Front/Park/Turn Lamps
 - » Clearance/Marker Lamps
 - » Signal Lamps
 - » Back Up Lamps
 - » Utility Lamps
 - » License Plate Lamps
 - » Dome Lights
 - » Work Lamps
- Pigtails
- Mounting Accessories
- Replacement Lens & Covers
- Reflectors

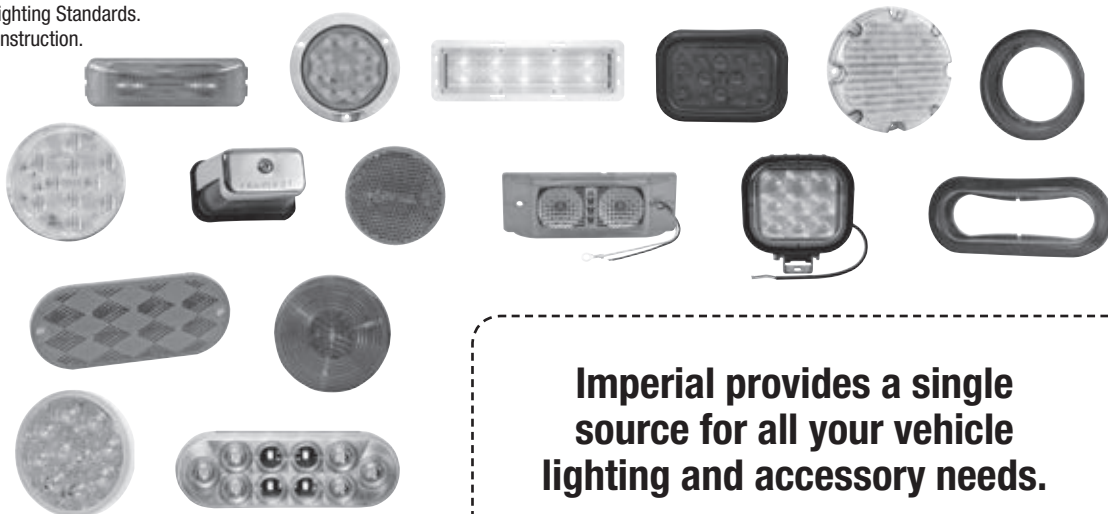

Imperial provides a single source for all your vehicle lighting and accessory needs.

TRUCK-LITE® VEHICLE LIGHTING

- Meets FMVSS 108 Federal Lighting Standards.
- Polycarbonate water tight construction.
- Lamp Styles:
 - » LED
 - » Incandescent
- Lamp Types:
 - » Stop/Turn/Tail Lamps
 - » Front/Park/Turn Lamps
 - » Clearance/Marker Lamps
 - » Signal Lamps
 - » Back Up Lamps
 - » Utility Lamps
 - » License Plate Lamps
 - » Work Lamps
 - » Multi-Function Lamps
- Pigtails
- Mounting Accessories
- Replacement Lens & Covers
- Reflectors



GROTE® VEHICLE LIGHTING

- Meets FMVSS 108 Federal Lighting Standards.
- Polycarbonate water tight construction.
- Lamp Styles:
 - » LED
 - » Incandescent
- Lamp Types:
 - » Stop/Turn/Tail Lamps
 - » Front/Park/Turn Lamps
 - » Clearance/Marker Lamps
 - » Signal Lamps
 - » Back Up Lamps
 - » Utility Lamps
 - » License Plate Lamps
 - » Work Lamps
 - » Multi-Function Lamps
 - » Dome Lamps
- Pigtails
- Mounting Accessories
- Replacement Lens & Covers
- Reflectors



Vehicle Lighting

PETERSON® VEHICLE LIGHTING

- Meets FMVSS 108 Federal Lighting Standards.
- Polycarbonate water tight construction.
- Lamp Styles:
 - » LED
 - » Incandescent
- Lamp Types:
 - » Stop/Turn/Tail Lamps
 - » Clearance/Marker Lamps
 - » Signal Lamps
 - » Back Up Lamps
 - » License Plate Lamps
 - » Work Lamps
- Pigtails
- Mounting Accessories
- Replacement Lens & Covers
- Reflectors



BETTS® VEHICLE LIGHTING

- Choke seal entrances available in all heavy wall lamps and junction boxes.
- Sealed housing and bulb is replaceable.
- Meets FMVSS 108 Federal Lighting Standards.
- Polycarbonate water tight construction.
- Lamp Styles:
 - » LED
 - » Incandescent
- Lamp Types:
 - » Stop/Turn/Tail Lamps
 - » Clearance/Marker Lamps
 - » Signal Lamps
 - » Back Up Lamps
 - » License Plate Lamps
 - » Work Lamps
- Pigtails
- Mounting Accessories
- Replacement Lens & Covers



STROBE LIGHTS

- LED and Incandescent
- Strobe Classes Available:
 - » Class I Strobe Lights
 - » Class II Strobe Lights
 - » Class III Strobe Lights
- Low Intensity Strobe Lights
- Strobe Lights Accessories
- Brands Include:
 - » Imperial®
 - » Ecco®
 - » Grote®
 - » Truck-Lite®



CONSPICUITY TAPE

- Available in roll or strip format.
- Color Patterns:
 - » Alternating Red/Silver
 - » Solid Silver
 - » Solid Red
 - » Solid Yellow
- Brands Include:
 - » Imperial®
 - » 3M™
 - » Reflexite®
 - » Grote®
 - » Peterson®

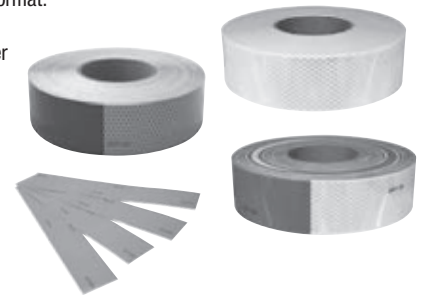

REPLACEMENT BULBS

- Halogen Capsule
 - » Fog Lamps
 - » Head Lamps
- Mini Bulbs
 - » Double Contact Bayonet
 - » Double Loop Bayonet
 - » Festoon Bulbs
 - » Miniature Bulbs
 - » Printed Circuit Socket Lamp
 - » Single Contact Bayonet
 - » Wedge Bulbs
- Sealed Beam Lamps
 - » Fog Lamps
 - » Head Lamps
 - » Work Lamps
- Strobe Bulbs

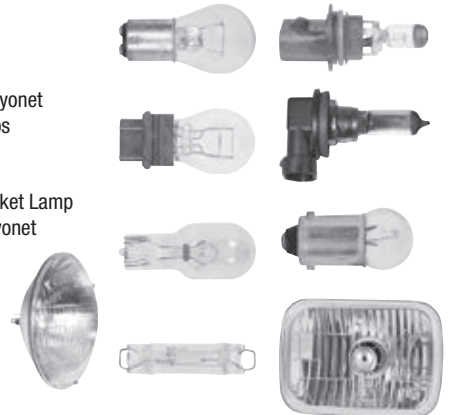

The Imperial Experts

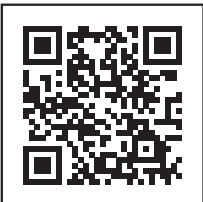

The Imperial Experts know fleet maintenance products.

Watch our product videos on YouTube.
Scan QR code using your mobile device.
In your web browser enter:
<http://isuppli.es/imperial-experts>

Imperial offers easy web ordering, inventory tracking, and purchasing controls.

Electrical

ELECTRICAL TERMINALS

- Heat Shrink Terminals
- Nylon Terminals
- Vinyl Terminals
- Solder Terminals
- Crimp, Solder, & Seal Terminals
- Pin Terminals
- Non-Insulated Terminals
- Special Application Terminals

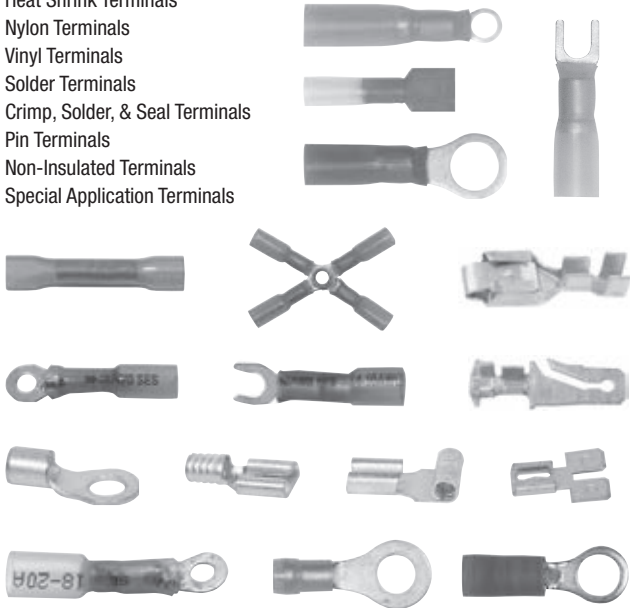

ELECTRICAL CONNECTORS

- Quick Lock Connectors
- Twist Wire Connectors

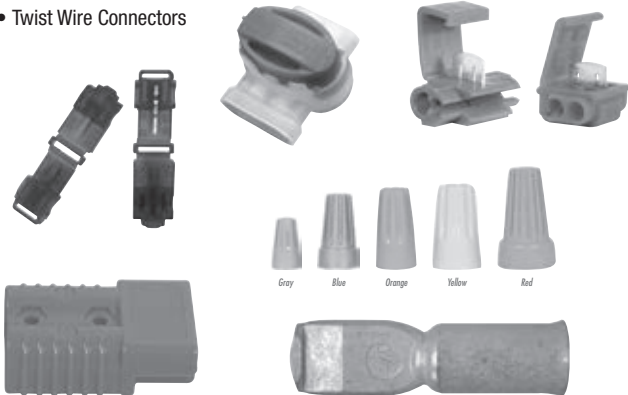

ELECTRICAL CONNECTION SYSTEMS

- Deutsch Connection System
 - » DT Series Connectors
 - » DTM Series Connectors
 - » Pin Terminals
 - » Connector Tools
- Weather Pack® Connection System
 - » Terminals
 - » Pre-Assembled Repair Leads
 - » Tower Terminals
 - » Shroud Terminals
 - » Connector Tools
- Metri-Pack® Connection System
 - » 150 Series
 - » 280 Series
 - » 480 Series
 - » 630 Series
 - » Connector Tools
- Pigtail Repair Harnesses



Experience our dedicated customer service.

The Imperial Experts



The Imperial Experts know fleet maintenance products.

Watch our product videos on YouTube.
Scan QR code using your mobile device.
In your web browser enter:
<http://isuppli.es/imperial-experts>

PRIMARY WIRE

- Cross-Link Primary Wire
- Plastic Primary Wire
- Parallel Primary Wire
- Jacketed Parallel Primary Wire
- Jacketed Conductor Primary Wire

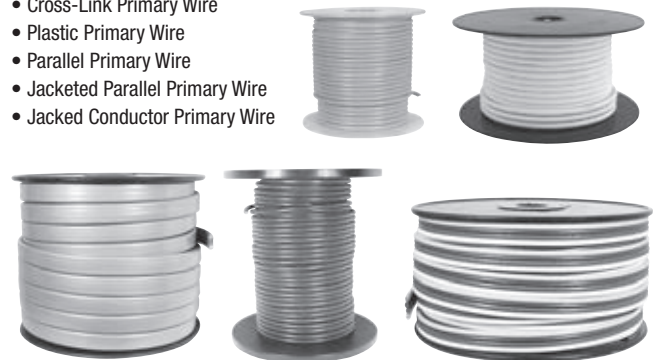

WIRE MANAGEMENT

- Nylon Cable Ties
 - » All Environmental Cable Ties
 - » Standard Cable Ties
 - » Colored Cable Ties
 - » Heavy-Duty Cable Ties
 - » Identification Cable Ties
 - » Metal Tab Cable Ties
 - » Mounting Style Cable Ties
 - » Releaseable Cable Ties
 - » Retainer Cable Ties
 - » Double Loop Cable Ties
- ETFE Cable Ties
- Steel Cable Ties
- Cable Tie Mounts
- Spiral Wrap
- Wire Loom
- Wire Marking Labels



HEAT SHRINK TUBING

- Heat Shrink Tubing
 - » Plastic Heat Shrink Tubing
 - » Polyolefin Heat Shrink Tubing
 - » MW Heat Shrink Tubing
- Butane Torches
- Electric Heat Gun



BATTERY SUPPLIES

- Battery Connectors
 - » Battery Terminals
 - » Battery Lugs
 - » Solder Plugs
 - » Solder Battery Terminals
 - » MagnaLug®
 - » Specialty Connectors
 - » Battery Bolts & Nuts
 - » Universal & Marine Battery Terminals
 - » Battery Cable Splices
- Battery Cable
 - » Color Coded Battery Cable
 - » Welding Cable
 - » Standard Battery Cable
 - » Conductor Wire
- Battery Cable Harnesses
- Battery Supplies
- Battery Accessories



BOOSTER PACKS & JUMPER CABLES

- Battery Booster Packs
- Battery Booster Pack Accessories
- Booster Cables
- Booster Cable Ends



For Imperial's most recently added products, visit imperialsupplies.com and click the 'new products tab' at the top of the webpage.

Electrical

ABS CORDS

- NHTSA approved method for powering trailers and dolly ABS systems.
- Provides 4/12, 2/10, 1/8 gauge electrical connections.
- Distinctive Green jacket color for instant recognition and identification.
- Available in 12 foot and 15 foot lengths.
- Coiled or straight types.
- Brands include
 - » Imperial®
 - » Sureflex®
 - » Phillips®



ABS SOCKETS / PLUGS

- Six and seven pin styles.
- Floating pins for ease of alignment and maximum contact.
- Socket Types:
 - » Zinc Diecast
 - » Glass Filled Nylon

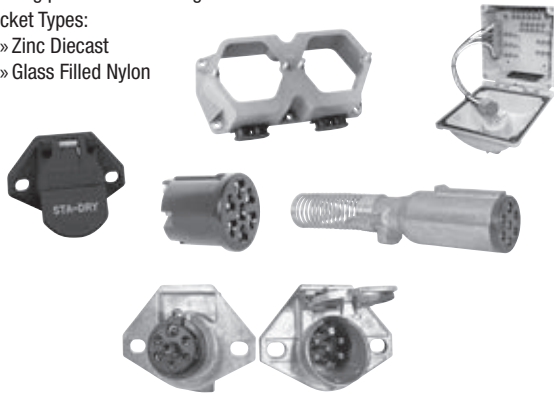

ISO CORDS / PLUGS / SOCKETS

- Use where a second tractor/trailer connection using ISO 3731 style connectors is required.
- Provides 4/12, 2/10, 1/8 gauge electrical connections.



LIFT GATE CORDS / PLUGS / SOCKETS

- Sockets, Plugs, and Cords
- Lift Gate Types:
 - » Single Pole Lift Gate
 - » Dual Pole Lift Gate
- Specialty Pole Lift Gate Cords

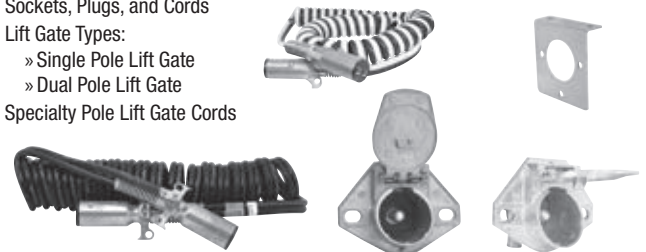

NON-ABS CORDS / PLUGS / SOCKETS

- Non ABS Components:
 - » Sockets
 - » Plugs
 - » Cords
 - » Adapters
 - » Flat Trailer Connectors
 - » Trailer Cable
 - » RV Style Connectors



ABS Cord Cross Reference Chart

LENGTH	STYLE	CONNECTION	PHILLIPS CROSS REFERENCE	IMPERIAL PART NO.	IMPERIAL BRAND PART NO.	SUREFLEX CROSS REFERENCE	IMPERIAL PART NO.
8'	Straight	Zinc Die Cast Ends	30-2011	73896	—	—	—
12'	Straight	Zinc Die Cast Ends	30-2051	73137	73593	SFA12SE	73179
12'	Straight	Quick-Change Plugs	30-2054	73919	—	—	—
15'	Straight	Zinc Die Cast Ends	30-2071	73876	73592	SFA15SE	73178
12'	Coiled	Zinc Die Cast Ends	30-4321	—	73590	SFA125CE	73175
12'	Coiled	Quick Change Plugs	30-4324	73880	—	—	—
15'	Coiled	Zinc Die Cast Ends	30-4621	73897	73591	SFA155CE	73177
15'	Coiled	Quick-Change Plugs	30-4624	73881	—	—	—
15'	Coiled with 48" Lead	Zinc Die Cast Ends	30-4921	—	73608	—	—
20'	Coiled	Zinc Die Cast Ends	30-4951	73145	—	—	—
12'	Coiled	Zinc Die Cast Ends	30-9321	—	73590	SFA125CE	73175
15'	Coiled	Zinc Die Cast Ends	30-9621	73138	73591	SFA155CE	73177
15'	Coiled	Quick-Change Plugs	30-9624	73148	—	—	—
15'	Coiled with 48" Lead	Glass Filled Nylon Plugs	30-9920	73902	—	—	—
15'	Coiled with 48" Lead	Zinc Die Cast Ends	30-9921	—	73608	—	—
15'	Coiled with 40" Lead	Zinc Die Cast Ends	—	—	73608	SFA155CE-40	73174
15'	Coiled with Volvo harness	Zinc Die Cast Ends	—	—	—	SFA155CE-VOLVO	73176

FUSES

- Glass Fuses
- Micro2 Fuses
- Micro3 Fuses
- ATO/ATC Fuses
- Blo & Glo® Fuses
 - » ATO
 - » ATM Mini
- Maxi-Fuses
- ATM-Mini Fuses
- ATM Mini Low Profile Fuses
- Emergency Fuse Fits
- Cartridge Fuses
- Industrial Fuses
- Bolt Down Fuses
- Fuse Accessories

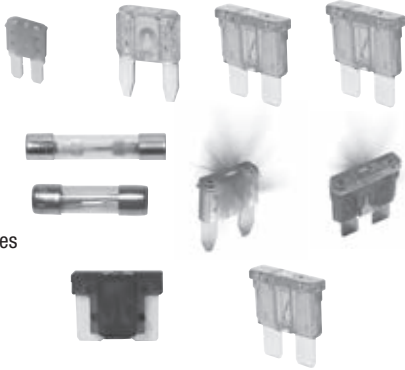

CIRCUIT BREAKERS

- ATO/ATC Circuit Breakers
- Mini Circuit Breakers
- Maxi Circuit Breakers
- High Amp Circuit Breakers
- Fuse Clip Circuit Breakers
- Quick Connect Breakers
- Wide Mini Footprint Circuit Breakers
- Stud Mount Circuit Breakers

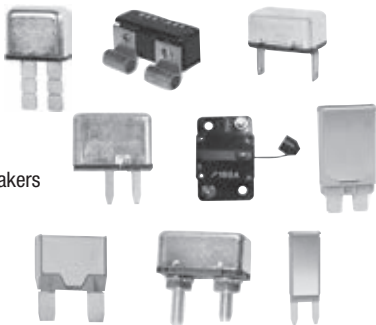

RELAYS

- A Pin Type
- B Pin Type
- B1 Pin Type
- B2 Pin Type
- B3 Pin Type
- C Pin Type
- D Pin Type
- Relay Connectors

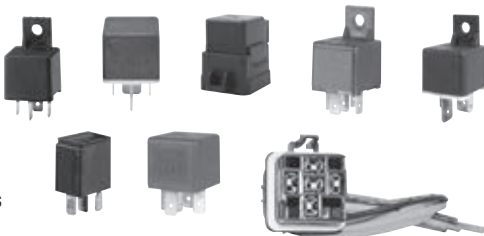

DATA & COMMUNICATION

- Coaxial Cable
- Coaxial Cable Connectors



FLASHERS

- Variable load
- Fixed load
- Electronic
- Thermal
- Brands include:
 - » Tridon®
 - » Bussmann®
 - » Grote®
 - » Truck-Light®



SWITCHES

- Disconnect Switches
- Rocker Switches
- Push/Pull Switches
- Starter Switches
- Toggle Switches



BACK UP ALARMS

- Model types:
 - » Self Adjusting
 - » Dual Function
- Noise types:
 - » Standard
 - » White Noise
- Brands include:
 - » Imperial®
 - » Ecco®
 - » Preco®



TEST INSTRUMENTS

- Voltage Meters
- Multi Meters
- Circuit Testers



GAUGES

- Hour Meters
- Hub Odometers
- Pressure Gauges



Tube & Tube Fittings

PIPE FITTINGS

BRASS PIPE FITTINGS

- Description:
 - » Can be used with brass or iron pipe.
 - » Working pressure to 1,200 psi.

- Fitting Types:
 - » Adapters
 - » Bushings
 - » Caps
 - » Couplings
 - » Crosses
 - » Elbows
 - » Nipples
 - » Plugs
 - » Tees
 - » Unions

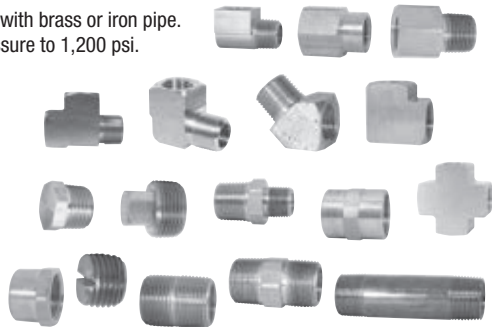

BLACK IRON / GALVANIZED PIPE FITTINGS

- Description:
 - » Meets or exceeds all applicable ASTM and ANSI standards.
 - » 300 psi rating: cold water, oil, or gas
 - » All fittings conform to American standards.
 - » 150 lb steam pressure.

- Fitting Types:
 - » Bushings
 - » Caps
 - » Couplings
 - » Elbows
 - » Nipples
 - » Plugs
 - » Tees
 - » Unions

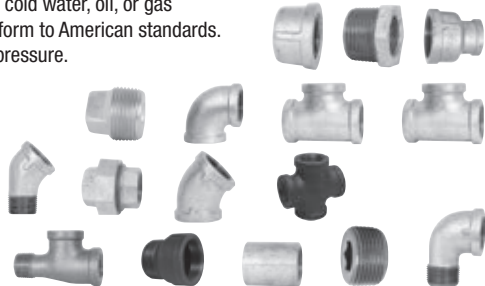

EXTRA HEAVY-DUTY BLACK IRON PIPE FITTINGS

- Description:
 - » Meets or exceeds all applicable ASTM and ANSI standards.
 - » 300 psi rating: cold water, oil, or gas; 150 lb steam pressure
 - » All fittings conform to American standards.

- Fitting Types:
 - » Bushings
 - » Caps
 - » Couplings
 - » Elbows
 - » Nipples
 - » Plugs
 - » Tees



HIGH PRESSURE STEEL PIPE FITTINGS

- Description:
 - » Working pressure up to 3,000 psi. Proof test rating 15,000 psi in sizes up to 1".
 - » It is recommended that all pipe threads be tightened approximately 2-1/2 full turns past hand tight.

- Fitting Types:
 - » Adapters
 - » Bushings
 - » Caps
 - » Couplings
 - » Elbows
 - » Nipples
 - » Plugs
 - » Tees

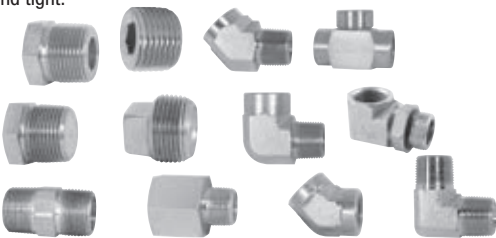

STAINLESS STEEL PIPE FITTINGS

- Description:
 - » Strongly resistant to ordinary rusting in food-processing.
 - » Resists organic chemicals, dyestuffs, a wide variety of inorganic compounds.
 - » Resists nitric and sulfuric acids at moderate temperatures and concentrations.

- Fitting Types:
 - » Bushings
 - » Caps
 - » Couplings
 - » Elbows
 - » Nipples
 - » Plugs
 - » Tees

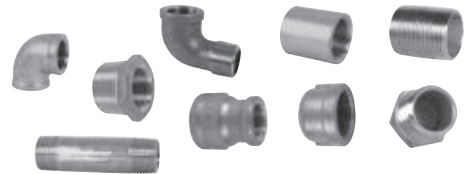

FLAT FACE O-RING FITTINGS

- Description:
 - » Applications: high pressure hydraulic, pneumatic and chemical processing.
 - » Maximum operating pressure: 6000 psi
 - » Sealing method: O-ring

- Fitting Types:
 - » Caps
 - » Connectors
 - » Elbows
 - » For-Seal O-rings
 - » Plugs
 - » Unions

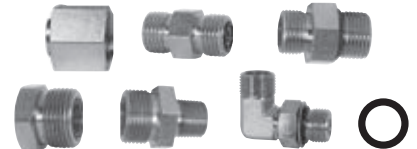

BOSS O-RING FITTINGS

- Fitting Types:
 - » Male Straight Thread O-ring to Male Pipe Adapter
 - » Straight Thread O-ring Hex Head Plug
 - » Straight Thread O-ring to Female Pipe Adapter

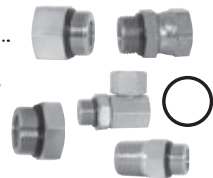

ADAPTERS

- Fitting Types:
 - » Boss O-ring Swivel Adapters
 - » ISO Port Adapters
 - » Split Flange Adapters
 - » Swivel Adapters



TUBING

TUBING

- Tube Types:
 - » Polyvinyl Chloride Tubing
 - » Polyethylene Tubing
 - » Nylon Tubing
 - » Food & Beverage Tubing
 - » PVC Tubing
 - » Steel Tubing
 - » Copper Tubing
- Tubing & Tube Fitting Tools

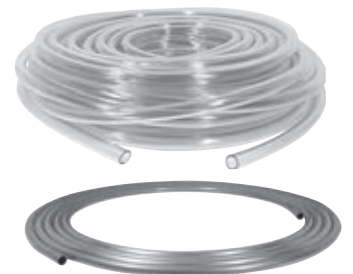

BULKHEAD FITTINGS

BULKHEAD FITTINGS

- Unions
- Couplings



Tube & Tube Fittings

FLARED FITTINGS

BRASS SAE 45° FLARE FITTINGS

- Description:
 - » Conformance: ASA, ASME, SAE and MIL standards
 - » Good resistance to vibration. Use long nut in applications with severe vibration
 - » Reusable.
- Fitting Types:
 - » Caps
 - » Connectors
 - » Elbows
 - » Flare Gaskets
 - » Nuts
 - » Plugs
 - » Tees
 - » Unions



STEEL SAE 37° (JIC) FLARE FITTINGS

- Description:
 - » Conformance: ASA, ASME, SAE and MIL standards
 - » Good resistance to vibration. Use long nut in applications with severe vibration. Reusable.
- Fitting Types:
 - » 3 Piece Sleeves
 - » Caps
 - » Connectors
 - » Elbows
 - » Nuts
 - » Plugs
 - » Reducers
 - » Swivel Nut to Pipe Adapters
 - » Tees
 - » Unions

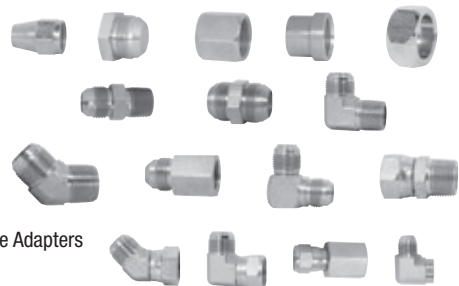

STEEL 37° (JIC) FLARE BOSS O-RING FITTINGS

- Fitting Types:
 - » Straight Thread 90° O-ring Connector
 - » Straight Thread O-ring 45° Elbow
 - » Straight Thread O-ring Connector
 - » Straight Thread O-ring Run Tee



INVERTED FLARE FITTINGS

- Description:
 - » Short-bodied fitting fits in tight places better than other styles of fittings.
 - » Conformance: ASA, ASME, SAE and MIL specifications
- Fitting Types:
 - » Connectors
 - » Elbows
 - » Nuts
 - » Plugs (Steel)
 - » Unions



BRAKE FITTINGS

BRAKE FITTINGS

- Fractional Brake Fittings
- Metric Inverted Flare Brake Fittings
- Metric Hydraulic Brake Fittings
- Brake Fittings Accessories
- Brake Lines



COMPRESSION TUBE FITTINGS

COMPRESSION TUBE FITTINGS

- Description:
 - » Easy and quick to assemble. Low cost. No tube flaring necessary.
 - » Conformance: SAE, ASA and ASME specifications
- Fitting Types:
 - » Compression Sleeves
 - » Connectors
 - » Elbows
 - » Nuts
 - » Tees
 - » Tube Support Inserts
 - » Unions



COMPRESSION TUBE FITTINGS W/ CAPTURED SLEEVE

- Description:
 - » Reduce your labor costs. Installation time is cut by 40% over standard compression fittings and 70% over SAE 45° flare fittings.
 - » For use with copper, aluminum and thermoplastic tubing.
- Fitting Types:
 - » Connectors
 - » Elbows
 - » Nut with Captive Sleeve
 - » Tees
 - » Unions



COMPRESSION TUBE FITTINGS W/ MACHINED INSERT

- Description:
 - » Easy to assemble, no flaring necessary.
 - » Pressure is up to 500 psi depending on tube size.
 - » Aluminum, copper and hard plastic tubing requires brass sleeve.
- Fitting Types:
 - » Connectors
 - » Elbows
 - » Nuts & Nut Assemblies
 - » Sleeves
 - » Tees
 - » Unions

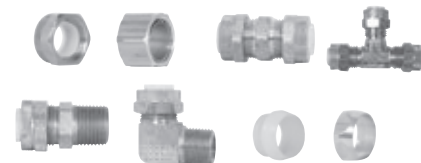

MINI BARBED FITTINGS

MINI BARBED FITTINGS

- Description:
 - » This one-piece fitting is designed specifically for use with plastic tubing.
 - » The barbed lip provides a safe, positive connection.
 - » Compact size permits use in extremely tight areas.
 - » Excellent vibration resistance.
- Fitting Types:
 - » Connectors
 - » Elbows
 - » Tees
 - » Unions

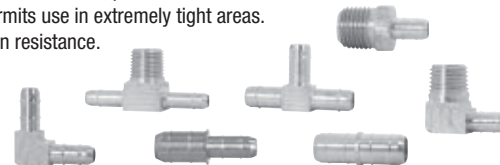

VALVES

VALVES

- Ball Valves
- Multiple Shut-Off Valves
- Ground Truck Valves
- Drain Cocks
- Truck Valves
- Needle Valves



Air Brake

(DOT APPROVED) AIR BRAKE FITTINGS FOR AIR BRAKE TUBING

COMPRESSION FITTINGS (BRASS)

- Description:
 - » Exceeds DOT pressure requirements for air brake systems.
 - » Use with SAE J844 Type A or B nylon tubing.
 - » Meets FMVSS 571.106 requirements.

- Compression Fittings Types:
 - » Bulkheads
 - » Connectors
 - » Elbows
 - » Inserts
 - » Nuts
 - » Sleeves (Ferrule)
 - » Tees
 - » Unions

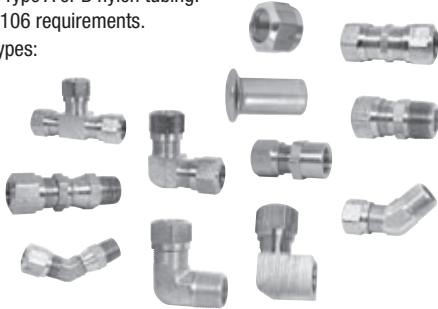

PUSH-TO-CONNECT FITTINGS (BRASS)

- Description:
 - » Full flow design, provides up to 60% more flow area than conventional fittings with internal tube supports.
 - » DOT approved and meets FMVSS-106 standards.
 - » Working Pressure: 250 psi

- Push-to-Connect (Brass) Types:
 - » Connectors
 - » Elbows
 - » Tees
 - » Unions



PUSH-TO-CONNECT FITTINGS (COMPOSITE)

- Description:
 - » Push to Connect fittings reduce installation time and cost.
 - » Composite body provides outstanding chemical resistance.
 - » Pipe threads are pre-sealed.

- Push-to-Connect (Composite) Types:
 - » Connectors
 - » Elbows
 - » Tees
 - » Unions



(DOT APPROVED) AIR BRAKE FITTINGS FOR RUBBER HOSE

COMPRESSION FITTINGS

- Description:
 - » Can be used for nearly any air brake system line.
 - » Easy to assemble with a good selection of low cost hose end configurations.
 - » Brass material offers excellent resistance against corrosion.

- Compression Fitting Types:
 - » Adapters
 - » Female Swivels
 - » Hose Connector Sleeves
 - » Hose Connector with Adapters
 - » Hose Connector with Spring Guards
 - » Hose Connectors
 - » Hose Menders
 - » Inserts
 - » Nut for Hose Connectors
 - » Nut for Spring Guards
 - » Spring Guards
 - » Spring/Nut Assemblies

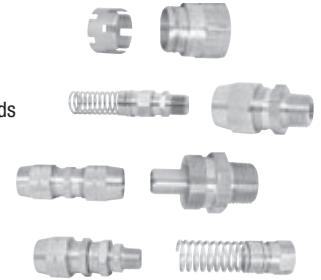

CRIMP STYLE FITTINGS

- Description:
 - » Brass material offers excellent resistance against corrosion.
 - » A permanent hose end saves time and is easy to assemble.

- Crimp Style Fitting Types:
 - » Air Brake Slider Lines
 - » Air Brake Swivels
 - » Male Pipe Swivels
 - » Male Rigid
 - » SAE 45° Female Swivels



FIELD INSTALLATION FITTINGS

- Description:
 - » Full DOT approval for use on air brake systems.
 - » Complete instructions included with each set.
 - » Male swivel hose ends.



AIR BRAKE TUBING (DOT APPROVED)

SIZES FROM 1/8" THROUGH 3/4"

- Designed specifically for air brake applications, instrumentation and air accessory systems.
- Color offered: Black, Red, Blue, Green, Yellow, Orange & White



(DOT APPROVED) RUBBER AIR BRAKE HOSE

SIZES FROM 3/8" THROUGH 1/2"

- Inner tube: synthetic EPDM
- Reinforcement: multi-fiber braid
- Sizes: 3/8" & 1/2"
- Cover: synthetic EPDM
- DOT approved.



Air Brake

AIR BRAKE ACCESSORIES

- Air Brake Diaphragms
- Air Tank Valves
 - » Air Tank Drain Valves
 - » Air Tank Fill Valves



(DOT APPROVED) AIR BRAKE FITTINGS FOR COPPER TUBING

COMPRESSION FITTINGS (BRASS)

- Description:
 - » Exceeds DOT pressure requirements for air brake systems.
 - » Use with SAE J844 Type A or B nylon tubing.
 - » Meets FMVSS 571.106 requirements.

Compression Fittings Types:

- » Connectors
- » Elbows
- » Nuts
- » Sleeve
- » Tees
- » Unions

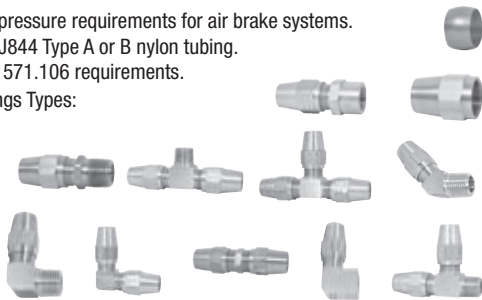

COPPER TUBING

SIZES FROM 1/8" THROUGH 1/2"

- Seamless. Bright annealed.
- Meets all federal and ICC standards.
- Standard or Heavy-Duty



(NOT DOT APPROVED) TRANSMISSION AIR LINES FITTINGS

NON DOT COMPRESSION FITTINGS (BRASS)

- Description:
 - » Applications: air control systems, instrumentation, water, air and lubrication lines
 - » Excellent vibration characteristics depend upon use of tubing.
 - » All fittings have split sleeves.
 - » Temperature range: -65° F to 250° F
- Compression Fittings Types:
 - » Male Connectors
 - » Male Elbows
 - » Nuts
 - » Sleeves
 - » Unions

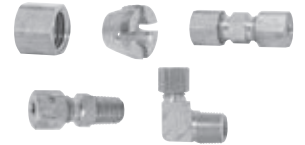

NON-DOT PUSH-TO-CONNECT AIR BRAKE FITTINGS

- Description:
 - » Use with compressed air.
 - » Maximum working pressure: 260 psi



Experience our dedicated customer service.

AIR BRAKE ASSEMBLIES & ACCESSORIES

- Coiled Air Brake Assemblies
- Straight Air Brake Assemblies
 - » Single Swivel
 - » Double Swivel
 - » Rigid
- Air Brake Assembly Accessories
- 5th Wheel Air Lines



GLAD HANDS & ACCESSORIES

- Glad Hands
- Glad Hand Seals
- Glad Hand Accessories



Hose & Hose Ends

HOSE

SIZES FROM 1/4" THROUGH 1-1/2"

LENGTHS FROM 50 FT THROUGH 500 FT REELS

BRANDS INCLUDE: GATES® & EATON® WEATHERHEAD®

- General Purpose Hose
 - » H100 General Purpose Fabric Cover
 - » H101 General Purpose Rubber Cover
 - » H201 General Purpose Cover
 - » H115 General Purpose – Oil Resistant
- Medium Pressure Hose
 - » A37AL-04 Medium Pressure Hydraulic Hose
 - » H104 Medium Pressure Hose
- High Pressure Hydraulic Hose
 - » H430 Very High Pressure
 - » H245 High Pressure – High Flex
 - » H425 High Pressure Fleet & Implement
 - » H190 High Pressure Hydraulic Hose
 - » H280 High Pressure – Hydraulic
 - » H145 High Pressure
 - » H470 Very High Pressure – Hydraulic
 - » Gates Global G2 2-Wire Hose
 - » Gates M2T High Pressure Hose
- Truck Hydraulic Hose
 - » H213 Medium Pressure DOT
 - » H069 Medium Pressure DOT
 - » H569 Hydraulic – ABS approved
- Refrigerant Hose
 - » H757 Air Conditioning
 - » GH1345W Multi-Refrigerant
- Suction Hose
 - » H039 Suction Hose
- LP Gas Hose
 - » H366 LP Gas Hose
- Coolant Hose
 - » Hi-Temp Heater Hose
 - » Standard Heater Hose
 - » Heavy-Duty Truck & Bus Hose
 - » Blue Silicone Heater Hose
 - » Gates® Green Stripe II Hose
 - » Gates® Green Stripe Coolant Hose Sticsl
 - » Radiator Hose Sticks
- Fuel Hose
 - » Standard Fuel Hose
 - » Gates® Barricade® Fuel Injection Hose
 - » Gates® Barricade® Carburetion Fuel Hose



HOSE ACCESSORIES

- Hose Protection
 - » Gates® Unicoil™
 - » Sleeve Protectors
 - » Hose & Cable Protectors
- Hose Cutting
 - » Electric Cutting Machines
 - » Multi-Cutter Hand Cutter
- Hose Storage
 - » Hose Centers
 - » Hose Cabinets
 - » Hose Shelves



Hose & Hose Ends

CRIMP HOSE ENDS

EATON® WEATHERHEAD®

- Eaton® Weatherhead® Coll-O-Crimp U Series Hose Ends
- Eaton® Weatherhead® Coll-O-Crimp U Series Flat Face Hose Ends
- Eaton® Weatherhead® Coll-O-Crimp 430 U Series Hose Ends
- Weathergrip™ Z Series Hose Ends
- Weathergrip™ STC Connectors
- Eaton® Weatherhead® Coll-O-Crimp 069 E Series Hose Ends

GATES®

- Gates® MegaCrimp® Hydraulic Fittings

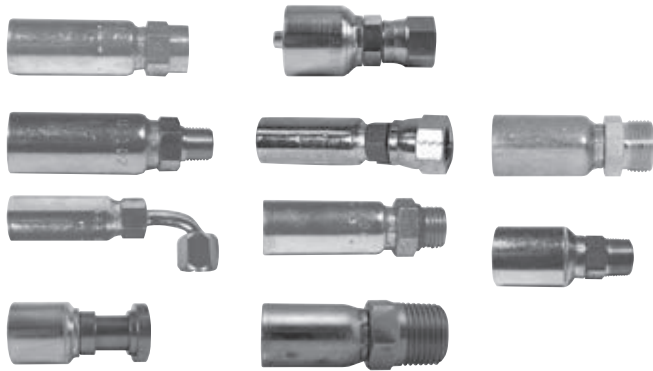

CRIMPING EQUIPMENT

EATON® WEATHERHEAD®

- Crimping Components
 - » Eaton® Weatherhead® Coll-O-Crimp® T-401-110 System
 - » Eaton® Weatherhead® Coll-O-Crimp® Super I Press with Electric Pump
 - » Eaton® Weatherhead® 3135 Portable Coll-O-Crimp® Package
 - » Eaton® Weatherhead® 3126 Portable Coll-O-Crimp Package

• Crimping Accessories

- » Stock Cabinets
- » Collet Racks
- » Digital Calipers
- » Collets
- » Spacer Rings

GATES®

- Crimping Components
 - » Gates® Power Crimp® 707
 - » Gates® MobileCrimp® 4-20
- Crimping Accessories
 - » 707 Power Source
 - » Die Sets
 - » Gates® MobileCrimp® Hand Pump
 - » Gates® MobileCrimp® Shop Air Pump
 - » Gates® MobileCrimp® 115 Volt Pump



Visit the Imperial website.
www.imperialsupplies.com

REUSABLE HOSE ENDS

EATON® WEATHERHEAD®

- Eaton® Weatherhead® 213 N Series Hose Ends
- Eaton® Weatherhead® 247 N Series Hose Ends
- Eaton® Weatherhead® 425 N Series Hose Ends

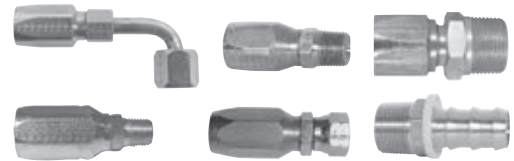

REFRIGERANT CRIMP HOSE ENDS

EATON® WEATHERHEAD®

- Eaton® Weatherhead® Coll-O-Crimp 757 E Series Hose Ends
- Eaton® Weatherhead® E-Z Clip System

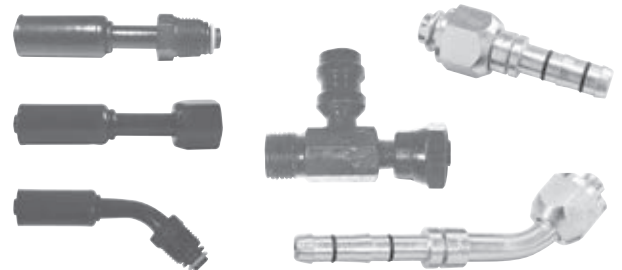

BARBED FITTINGS

- Fuel Fittings
 - » Brass Fuel Fittings
- Coolant Fittings
 - » Brass Heater Hose Fittings
 - » Connectors
 - » King Nipples

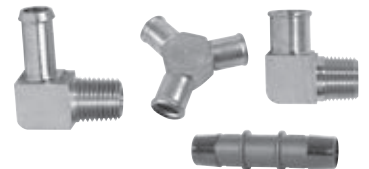

VACUUM CONNECTORS

- Vacuum Connectors
- Vacuum Hose
- Vacuum Caps
- Material include:
 - » Polyethylene
 - » Rubber
 - » Plastic
 - » Nylon



Cutting Tools

SABRE® MECHANICS LENGTH DRILL BITS

MECHANIC LENGTH: SIZES FROM 1/16" THROUGH 1/2"

- 135°, self-centering split-point eliminates walking and provides quicker penetration.
- 3-flat shank provides a positive grip in cordless, keyless, and conventional power tools.
- Shorter overall length and reduced flute length provides increased rigidity.
- Premium grade high-speed steel.
- Ideal for drilling in high carbon steel, stainless steel, and other hard metal applications.
- NOTE: 3-flat shank only on 3/16" and larger sizes.

REDUCED SHANK: SIZES FROM 27/64" THROUGH 1/2"

- Same quality features of the Sabre® Mechanics Length Drills.
- Larger diameter drill bits can fit into a 3/8" size chuck.

DRILL BIT INDEX: SIZES FROM 1/16" THROUGH 1/2" BY 64THS WITH OR WITHOUT REDUCED SHANK

- Includes a durable metal index case.

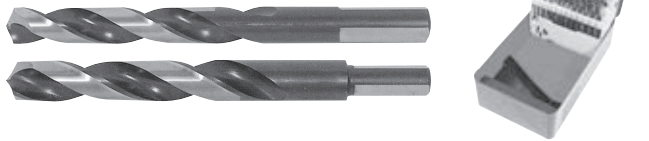

IMPERIALALLOY™ HEAVY-DUTY JOBBER LENGTH DRILL BITS

JOBBER LENGTH: SIZES FROM 3/64" THROUGH 1/2"

- Designed for drilling stainless steel and high alloy tool steels.
- Web design resists breakage under stress.
- 135° split-point will not wander at the starting surface.
- No center punching is required.
- Meets Aerospace NAS-907B specifications.
- Premium grade high speed steel.

DRILL BIT INDEX: SIZES FROM 1/16" THROUGH 1/4" OR 1/2" BY 32ND OR 64THS

- Includes durable metal index case.



Imperial Alloy™

SABRE® JOBBER LENGTH DRILL BITS

JOBBER LENGTH: SIZES FROM 27/64" THROUGH 1/2"

- Designed to drill through all types of materials, even stainless steel.
- Industrial heavy-duty web allows for increased feed rates and a stronger bit.
- 135° split-point eliminates drill wandering and center punching.
- The unique flute design improves chip ejection and coolant flow to the drill point, which allows the drill bit to remain cool.
- Premium grade high-speed steel.

REDUCED SHANK: SIZES FROM 25/64" THROUGH 1/2"

- All the features of Sabre Bits but with a 3/8" reduced shank for smaller drills.

DRILL BIT INDEX: SIZES FROM 1/16" THROUGH 1/2" BY 64I WITH OR WITHOUT REDUCED SHANK

- Includes a durable metal index case.

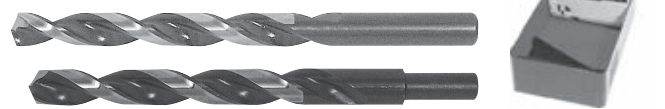

OTHER DRILL BITS

- Tin Coated Drill Bits
- Cobalt Alloy Drill Bits
- General Duty Drill Bits
- Silver & Deming Drill Bits
- Number Size Drill Bits
- Letter Size Drill Bits
- Specialty Drill Bits
 - » Masonry Drill Bits
 - » Aircraft Drill Bits
 - » Double-Ended Drill Bits
 - » Stubby Drill Bits
 - » Spot Weld Drill Bits
 - » Screw Machine Length Drill Bits
 - » Left Hand Drill Bits
 - » Metric Drill Bits



DRILL BIT ACCESSORIES

- Chucks
- Chuck Key
- Drill Bit Stops
- Cutting Oil
- Drill Bit Storage Cabinets
- Drill Bit Storage Indexes



DRILL BIT SHARPENING

- Drill Doctor® Drill Bit Sharpener
- Drill Doctor® Replacement Parts



Cutting Tools

HOLE EXPANSION BITS

- Reamers
- Reamer Sets
- Step Down Drill Bits

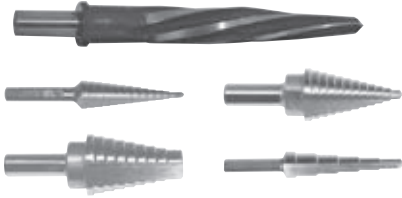

EXTRACTORS

- Extractor Bits
- Drill-Out® Broken Bolt Extractor Set
- X-Out™ Damaged Screw Set



COUNTERSINKS

- 82° Pilotless Countersinks
- 118° Combined Drill and Countersink



TAPS & DIES

- Taps
 - » Fractional
 - » Metric
- Dies
 - » Fractional
 - » Metric
 - » Round
 - » Hex
- Tap & Die Tools
- Tap & Drill Sets
- Combo Drill & Taps

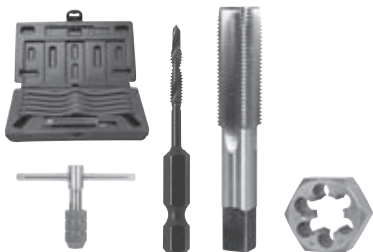

HOLE SAWS

- Bi-Metal Hole Saws
- Carbide Tip Hole Saws
- Hole Saw Kits
- Hole Saw Arbors
- Replacement Pilot Drill Bit



UTILITY KNIVES & BLADES

- Utility Knives
- Snap-off Knives
- Utility Knife Blades
- Utility Knife Dispensers
- Blade Bank Container



SCRAPERS & REPLACEMENT BLADES

- Retractable Scrapers
- Folding Scrapers
- Heavy-Duty 4" Scrapers
- Replacement Blades
 - » Razor Blades
 - » Plastic Razor Blades



BLADES

- Reciprocating Blades
- Circular Saw Blades
- Band Saw Blades

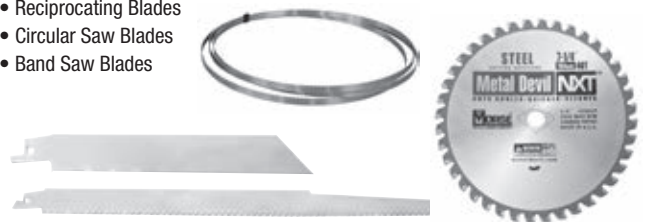

HACKSAWS & HACKSAW BLADES

- Hacksaws
- Hacksaw Blades



Think safety first. Always.
Imperial offers a wide range
of Safety Products.

Abrasives

SANDING DISCS

VARIOUS SIZES & FINISHES

- Styles include:
 - » Quick Change
 - » Adhesive (PSA)
 - » Hook & Loop
 - » Arbor & Mandrel Mount
- Brands include:
 - » Imperialok®
 - » 3m™
 - » Norton®

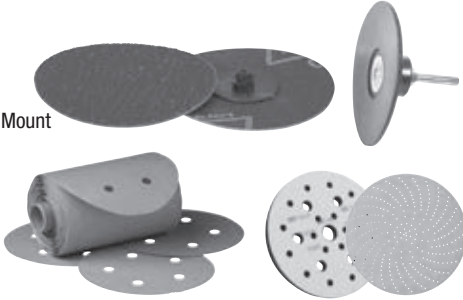

SURFACE CONDITIONING DISCS

VARIOUS SIZES & FINISHES

- Styles include:
 - » Quick Change
- Brands include:
 - » Imperialok®
 - » 3m™
 - » Norton®

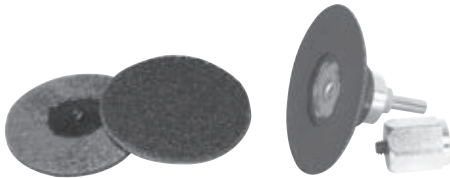

BRISTLE DISCS

SIZES FROM 1" THROUGH 3" DIAMETER

- Remove paint, rust, scale, gaskets and welding residues from surfaces.
- For use with die grinders or hand drills

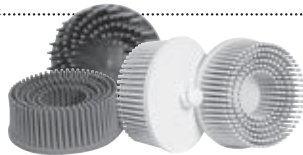

CUT-OFF WHEELS

VARIOUS SIZES

- Brands include:
 - » 3M™
 - » Norton®
 - » Flexovit®
 - » Pferd®
- Types:
 - » Type 1, Type 27



CUT-OFF BLADES

SIZES 7", 12, 14, 16 DIAMETERS

- Brands include:
 - » Norton®
 - » Flexovit®



GRINDING WHEELS

- Styles include:
 - » Grinding Cup Wheels
 - » Bench Grinding Wheels
 - » Hubbed
 - » Unhubbed
- Shapes include:
 - » Type 1, Type 2, Type 27, Type 28, Type 29
- Brands include:
 - » Norton®
 - » Flexovit®
 - » Dewalt®
 - » Pferd®



FLAP WHEELS

VARIOUS SIZES

- Mounted Flap Wheels
- Unmounted Flap Wheels



FLAP DISCS

VARIOUS SIZES

- Shapes include:
 - » Type 28
 - » Type 27
 - » Type 29



If you can't find the products you are looking for, call us, and we will find it for you.

Abrasives

DECAL REMOVAL

- Removal Tools & Accessories
- Removal Wheels

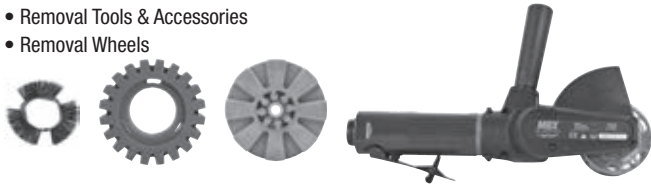

BAND & ROLL ABRASIVES

- Cartridge Roll Abrasives
- Expanding Drums
- Spiral Band Abrasives
- Spiral Point Abrasives
- Mandrels

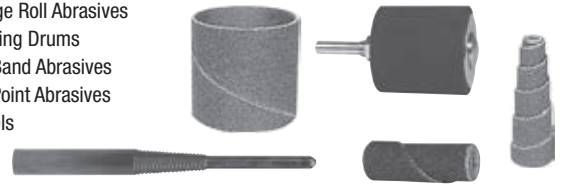

STRIPPING & REMOVAL DISCS

- 3M™ Clean and Strip Discs
- Scotch-Brite™ Roloc™ Coating Removal Discs
- Unitized Wheels
- 3M™ Scotch-Brite™ Finishing Flap Brushes

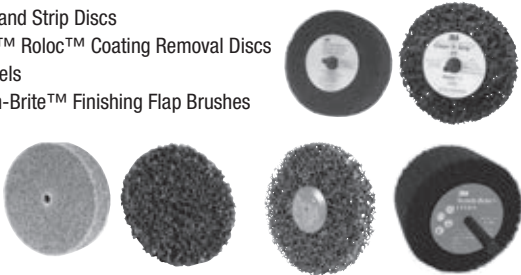

MOUNTED POINTS

- Most commonly used in grinding applications

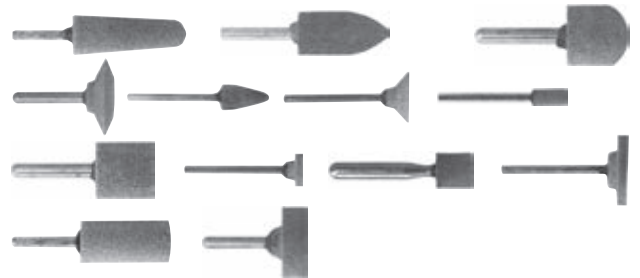

SHEET & ROLL ABRASIVES

- Emery Cloth
- Mechanics Cloth
- Screen Cut
- Crocus Cloth
- Sanding Sheets & Holders
- Conditioning Pads



CARBIDE BURS

- Material Types
 - » Steel & Stainless Steel
 - » Aluminum & Non-Ferrous
- Shapes Include:
 - » A, C, D, E, F, G, L, M



WIRE ABRASIVES

- End Brushes
 - » Crimped or Knotted Styles
- Cup Brushes
 - » Crimped or Knotted Styles
- Wire Wheel Brushes
 - » Crimped or Knotted Styles



HAND ABRASIVES

- Wire Brushes
- Files
 - » Half Round Files
 - » Flat Files
 - » Round Riles
- Plumbing Fitting Brushes
- Flue Brushes
- Scratch Brushes
- File Card

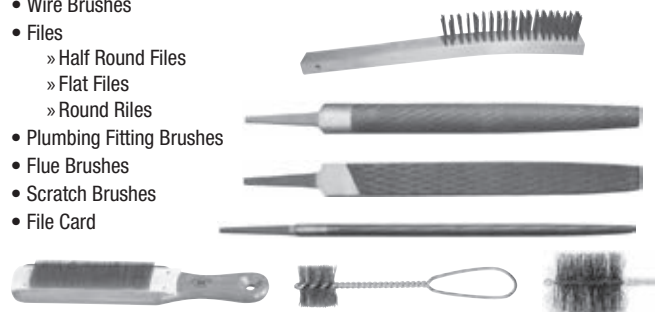

Safety

HAND PROTECTION

- Anti-Vibration Gloves
- Canvas, Jersey, & Chore Gloves
- Coated Gloves
- Cold-Condition Gloves
- Cut Resistant Gloves
- Disposable Gloves
- Drivers Gloves
- Glove Dispensers
- Insulated Gloves
- Kevlar Gloves
- Leather Palm Work Gloves
- Mechanics Gloves
- Nitrile Gloves
- Latex Gloves
- PVC Gloves
- String Knit Gloves
- Welding Gloves



EYE PROTECTION

- Safety Glasses
 - » All meet ANSI requirements
 - » Clear, Shaded and UV protection lenses
 - » Over the glass Style
 - » Frameless Style
 - » Prescription / Readers Style
 - » Wrap Around Style
- Protective Goggles



FACE PROTECTION

- Face Shield Assemblies
- Face Shield Replacement Visors
- Face Shield Accessories

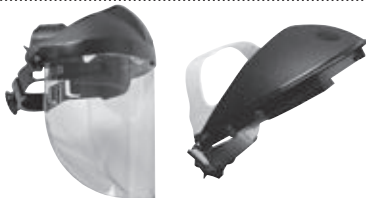

ERGONOMICS

- Back Support Belts
- Protective Knee Pads

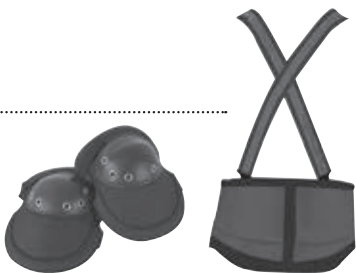

HEARING PROTECTION

- Many styles to choose from
- Corded, Cordless or Headband Styles
- Disposable Styles
- Reusable Styles
- Ear Muffs



RESPIRATORY PROTECTION

- Disposable Respirators
- Reusable Respirators
- Cartridges & Filters
- Each rated for type of application.



FIRST AID KITS

- General Purpose First Aid Kits
- School Bus First Aid Kit
- Body Fluid & Spill Clean Up Kit
- First Aid Supplies
- Empty First Aid Cabinets



EMERGENCY EYE WASH EQUIPMENT

- Emergency Eye Wash Stations
- Eye Wash Solutions
- Eye Wash Additives
- Eye Wash Inspection Tags
- Eye Wash Station Sign



FIRE PROTECTION

- Fire Extinguishers
- Mounting Brackets



SLIP & FALL PROTECTION

- Footwear Traction Devices
- Anti-Slip Tape
- Anti-Slip Chemicals



HEAD PROTECTION

- Hard Hats
- Bump Caps
- Chin Strap



IDENTIFICATION PRODUCTS

- Right to Know Placards, Signs & Labels
- Vehicle Placard & Placard Holders
- Accident Reports
- Pipe Markers
- Dispatch Hang Tag Numbers
- PSI Stickers
- Parts Tags
- Facility Signs



SAFETY STORAGE

- Oily Waste Cans
- Safety Cabinets



LOCKOUT DEVICES

- Lockout Bags & Tags
- Security Seals
- Lockout Centers & Stations
- Lockout Hasps
- Electrical & Switch Lockout Devices
- Padlocks
- Accident Prevention Tags



WORKWEAR

- Traffic Safety Vests Classes 1, 2 & 3
- Traffic Safety Belts & Wrist Bands
- Cold Weather Headwear
- Disposable & Chemical Resistant Clothing
- Head Bands, Sweat Bands, & Cooling Headwear
- Rainwear



TRAFFIC SAFETY

- Triangle Reflector Warning Kits
- Traffic Safety Cones
- Wheel Chocks
- LED Flare Kits

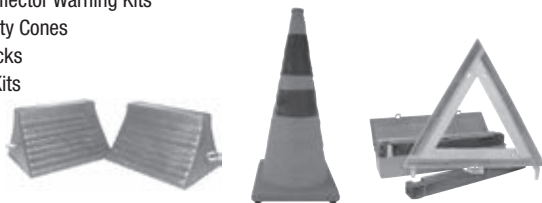

SPILL CONTROL

- Sorbents
 - » General Purpose
 - » Oil Selective
- Sorbent Socks
- Sorbent Rolls
- Sorbent Spill Kits
- Emergency Wood Plugs
- Loose Absorbents
- Chemical Neutralizers
- Secondary Spill Control
- Drain & Drip Pans
- Portable Berms

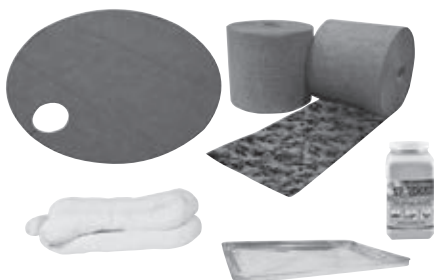

HYDRATION

- Sports Drinks
- Portable Coolers
- Disposable Cups



Imperial offers a complete line of Personal Protective Equipment Products.

Paint & Paint Supplies

The Imperial Experts



The Imperial Experts know fleet maintenance products.

Watch our product videos on YouTube.

Scan QR code using your mobile device.

In your web browser enter:

<http://isuppli.es/imperial-experts>

MARKING PAINTS

- Imperial®
- Seymour®



IMPERIAL ECOSAFE® ENAMEL SPRAY PAINTS

- Over 100 different paint colors available.
- High solid paints.
- Dry to the touch in five minutes at 70° F, 50% relative humidity.
- Resists abrasion and corrosive chemicals.
- Retains smooth finish and resists fading longer than most spray paints.
- Paint color is stamped on the can.
- Imperial offers:
 - » 20 oz cans (15 oz net weight)
 - » 16 oz cans (12 oz net weight)
 - » 13 oz cans (10 oz net weight)
 - » 1 gallon containers



MARKING PAINT ACCESSORIES

- Marking Wands
- Marking Paint Pistols



OTHER BRAND SPRAY PAINTS & SPRAY PRIMERS

- Krylon®
- Seymour®
- Dupli-Color®
- Rust-Oleum®



SPRAY PAINT ACCESSORIES

- Spray paint guns
- Spray paint nozzles



Chemical product orders from Imperial include MSDS for maintaining OSHA Compliance.

View MSDS 24/7 on our website at www.imperialsupplies.com

Paint & Paint Supplies

PAIN T BRUSHES

- Straight Paint Brushes
- Angled Paint Brushes
- Disposable Paint Brushes
- Chip & Oil Brushes
- Stain & Varnish Brushes
- Foam Paint Brushes



PAIN T ROLLERS

- Roller Frames
- Foam Rollers



OTHER PAINT PRODUCTS

- Paint Pens & Markers
- Stencil Ink
- Grease Markers
- Touch-up Paint



PAINTING SUPPLIES

- Roller Trays
- Floor Protector
- Putty Knife
- EZ Pour Lid
- Mix & Measure Containers
- Paint Mixers
- Stir Stick Paddles
- Masking Paper
- Drop Cloth
- Protective Sheeting
- Masking Film



The Imperial® Product Line provides a high level of quality while saving you money.

Chemicals

LUBRICANTS

- PTFE Lubricants
- Food Grade Lubricants
- General Purpose Lubricants
- Heavy Duty Lubricants
- Silicone Lubricants
- Graphite Lubricants
- Gear & Chain Lubricants
- Grease Lubricants



RUST PROTECTORS & CONVERTORS

- Rust protectors
- Rust convertors
- Brands Include:
 - » Imperial®
 - » Corrosion X®
 - » B'laster®
 - » Fluid Film®
 - » Zep®
 - » Permatex®



BRAKE PARTS CLEANER

- Standard Formulas
- Non-Chlorinated Formulas
- Biodegradeable Formulas
- CA/OTC Compliant Formulas
- Brands include:
 - » Imperial®
 - » Sprayon®
 - » Zep®
 - » CRC®
 - » Permatex®



RUBBERIZED UNDERCOATS & PANEL COATINGS

- Brands Include:
 - » Imperial®
 - » 3M™
 - » Permatex®



DEGREASERS & CLEANERS

- Glass Cleaner
- All Purpose Cleaners
- General Citrus Degreasers
- Vandal Mark Removers
- Gasket Removers
- Engine Degreasers
- Decal & Sticker Removers
- Carb & Choke Cleaners



AIR TOOL CHEMICALS

- Brands Include:
 - » B'laster®
 - » Marvel®



ELECTRICAL PROTECTORS & CLEANERS

- Electrical Protectors
- Electrical Cleaners
- Electrical Contact Cleaners
- Brands Include:
 - » Imperial®
 - » CRC®
 - » Sprayon®
 - » Permatex®
 - » Perfomix®
 - » I-Chem®



CUTTING OILS

- Brands Include:
 - » Imperial®
 - » Tap®
 - » Zep®



Chemical product orders from Imperial include MSDS for maintaining OSHA Compliance.

View MSDS 24/7 on our website at www.imperialsupplies.com

INSECTICIDES

- Wasp & Hornet Killer
- Insect Repellent
- Roach & Ant Killer



LEAK SEALERS & GAP FILLERS

- Multi-Purpose Leak Sealer
- Expanding Insulating Foam



SPRAY ADHESIVES

- Web Trim Adhesive
- All Purpose Adhesive
- Carpet Adhesive



ADDITIVES

- Anti-Freeze & Anti-Gel Additives
- Fuel & Engine Oil Additives
- Fuel Injector Cleaner Additives
- Brake Line De-Icers
- Starting Fluid
- Power Steering Fluid
- Air Brake Additives
- Windshield Washer Concentrate
- Brake Fluid
- Air Conditioning Additives
- Transmission Additives
- Radiator Additives



COIL CLEANERS

- Brands Include:
 - » Imperial®
 - » Sprayway®
 - » Zep®



BRAKE LUBRICANTS

- Brake Quiet
- Caliper Lube
- Brake Parts Lubricant
- Brake Anti-Seize
- Silicone Paste
- Silicone Compound



GREASES

- Multi-Purpose Grease
- Heavy-Duty Grease
- Bio-Based Moly Grease
- Machinery Grease
- 5th Wheel Trailer Grease
- Lithium Grease
- Wheel Bearing Grease



DIELECTRIC GREASES

- Brands Include:
 - » Permatex®
 - » CRC®
 - » Dynatex®
 - » Super Lube®
 - » Truck-Lite®



THREADLOCKERS

- Medium Strength
- Green Medium Strength
- High Strength



THREAD SEALANTS

- Pipe Sealant with PTFE
- Pipe Joint Compound
- Thread Sealant with PTFE



ANTI-SEIZE

- Nickel Anti-Seize
- Copper Anti-Seize
- Anti-Seize & Lubricating Compound



Chemicals

GASKET MAKERS & SEALANTS

- Brands include:
 - » Dynatex®
 - » Permatex®



RTV SILICONES

- Black RTV Silicones
- Yellow RTV Silicones
- Blue RTV Silicones
- Clear RTV Silicones
- Red RTV Silicones
- Gray RTV Silicones
- Copper Silicone Gasket Makers



CAULK & SEALERS

- Brands Include:
 - » Sikaflex®
 - » White Lightning®
 - » Manus Bond
 - » Permatex®
 - » Eclectic®
 - » Dap®



STRUCTURAL ADHESIVES

- Brands Include:
 - » Norton®
 - » 3M™



WINDSHIELD ADHESIVES & PRIMERS

- Brands Include:
 - » SikaTack®
 - » 3M™



VEHICLE ADHESIVES & SEALERS

- Trim Adhesives
- Emblem Adhesives
- Auto Body Sealant
- Muffler & Tailpipe Sealant
- Seam Sealers



GLUES & CEMENTS

- Weatherstrip Adhesive
- Specialty Adhesives
 - » E-6000
 - » HH-66 Cement
 - » PVC Bonding Adhesive
- Instant Adhesives
- Epoxy



CHEMICAL DISPENSING

- Dispensing Systems
- Containers with Faucet
- Brush Top Cans
- Trigger Spray Bottles
- Pneumatic Applicators



Chemical product orders from Imperial include MSDS for maintaining OSHA Compliance.

View MSDS 24/7 on our website at www.imperialsupplies.com

JANITORIAL CHEMICALS

- Disinfectants
- Mildew Removers
- Drain Cleaners
- Sanitizer
- Toilet Bowl Cleaner
- Calcium Lime Rust Remover
- All Purpose Cleaner
- Concrete Cleaner
- Glass Cleaner



HAND CLEANERS & DISPENSERS

- Hand Cleaner Brands Include:
 - » GOJO®
 - » Touch®
 - » Micrell®
 - » Boraxo®
 - » Permatex®
 - » Zep®
- Hand Cleaner Dispensers
- Hand Cleaner Accessories
- Hand Sanitizers



ODOR CONTROL

- Metered Aerosols
- Automatic Toilet Cleaners
- Urinal Screens
- Deodorizing Floor Mats
- Deodorizer Dispensers
- Air & Surface Deodorizers



SHOP RAGS & TOWELS

- Wipes on Roll
- Dispensing Shop Towels
- Dispensing Wet Wipes
- Shop Towels



PAPER PRODUCTS

- Center Pull Towels
- Multi-Fold Towels
- Paper Towels Dispensers
- Toilet Tissue & Dispensers
- Toilet Seat Covers & Dispensers
- Facial Tissue



TRASH BAGS & LINERS

- Wide range of sizes and densities to meet your needs.
- Sizes: 7-60 gallon
- Colors: Clear, Gray, Black



CLEANING SUPPLIES

- Sponges & Scouring Pads
- Brooms
- Floor Squeegees
- Handles, Frames, & Braces
- Cleaning Supplies Holders
- Dust Pans
- Brushes & Hand Brooms
- Plungers
- Mops & Dusters
- Mop Accessories
- Buckets & Pails



Shop Supplies

SHOP AIR HOSE

- Air Hose Types:
 - » Rubber
 - » PVC
 - » Polyurethane
- Quick Connect Couplers & Plugs
- Barbed Fittings
- Reusable Air Hose Fittings
- Air Assemblies & Air Whips
- Hose Reels



PNEUMATIC TOOLS

- Blow Guns
- Die Grinders
- Air Hammers
- Percussion Tools
- Sanders



GENERAL WASHING

- Wash Hose
- Wash Hose Ends
- Spray Nozzles



PRESSURE WASHING

- Pressure Washing Hose
- Lances & Lance Accessories
- Spray Guns & Handles
- Couplers & Swivels
- Spray Nozzles



EXTENSION CORDS

- Extension Cord Styles Include:
 - » Heavy-Duty
 - » All-Weather Heavy-Duty
 - » Retractable Reels
 - » Lighted End
- Extension Cord Accessories



Reorder essential products
simply and quickly.

LIGHTING

- Trouble Lights
- Fluorescent Work Lights
 - » Reel Style Corded Fluorescent Work Lights
 - » Corded Fluorescent Work Lights
 - » Cordless Fluorescent Work Lights
- LED Work Lights
- Replacement Bulbs
- Replacement Fluorescent Bulbs
- Flashlights & Replacement Bulbs
- Specialty Bulbs



BATTERIES

- Standard Batteries
- Coin Cell & Specialty Batteries
- Rechargeable Batteries
- Battery Chargers



ELECTRICAL BOXES & RECEPTACLES

- Electrical Boxes
- Receptacles
- Box Covers



TAPE

- Electrical Tape
- Film Tapes
- Foam Tapes
- Masking Tapes
- Packaging Tapes
- Marking & Warning Tapes
- Labeling Tapes
- Reclosable Tapes
- Duct & Cloth Tapes
- Anti-Slip Tapes
- Sealant Tapes

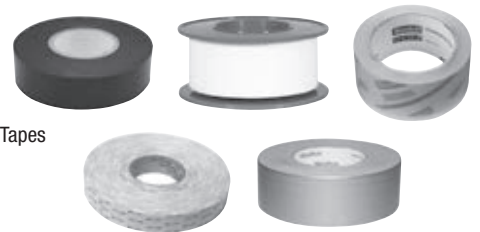

MAINTENANCE TOOLS

- Funnels & Fillers
- Hand Oilers



Shop Supplies

LUBRICATION

- Grease Fittings
 - » Heavy-Duty Grease Fittings
 - » Drive Style Grease Fittings
 - » Standard Grease Fittings
 - » Self-Forming Grease Fittings
 - » Metric Grease Fittings
 - » Buttonhead Grease Fittings
 - » Quicklinc Push-in Grease Fittings
- Grease Couplers
- Grease Hoses
- Grease Guns



DRUM & BARREL PUMPS

- Drum & Barrel Pumps
- Drum & Barrel Accessories



VEHICLE LIFTING TOOLS

- Bottle Jacks
- Jack Oil



LEAK DETECTION

- Leak Finding Kits
- Leak Finding Dies
- Injection Systems



PARTS WASHING

- Parts Washing Solution
- Ozzy™
- Parts Cleaner Brush



TOOL BOXES & STORAGE

- Tool Bags
- Tool Boxes



HAND TOOLS

- Butane Torches
- Bolt Cutters
- Cable Cutters & Crimpers
- Hose Cutters
- Electrical Connection Tools
- Magnetic Pickups
- Magnetizer
- Wire Strippers, Crimpers, & Cable Splitters
- Nut Drivers
- Screw Drivers
- Punches
- Measuring & Layout Tools
- Hex Drivers
- Drive Bits
- Hex & Torx Key Sets



VEHICLE CLEANING & APPEARANCE

- Interior Protectants & Cleaners
- Waxes & Polishes
- Compounds
- Scratch Removers
- Surface Preparation
- Polishing Pads
- Detailing Supplies
- Exterior Restoration
- Scrub & Wash Brushes
- Squeegees
- Wash
- Tire & Wheel Cleaner
- Chrome & Metal Polish
- Restoration & Repair Kits



WELDING

- Electrodes
- Welding Rods
- Solder Products
- Welding Wire
- Welding Helmets
- Replacement Lenses
- Welding Accessories
- Welding Workwear

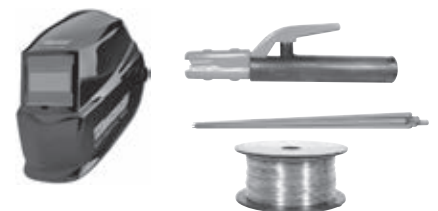

Vehicle & Trailer Parts

DOOR HARDWARE

- Replacement components for your door hardware needs.
- Interchangeable with other major brands.
- Brands include
 - » Todco®
 - » Whiting®
 - » Diamond®



DOCK BUMPERS

- Delivers shock proof protection in a variety of ways to meet your needs.



LOAD CONTROL

- Load Binders
- Transport Chains
- Winch Straps
- Load Control Accessories
- Load Control Hardware
- Ratchet Assemblies
- Tarp Straps
- Winch Bars
- Winches

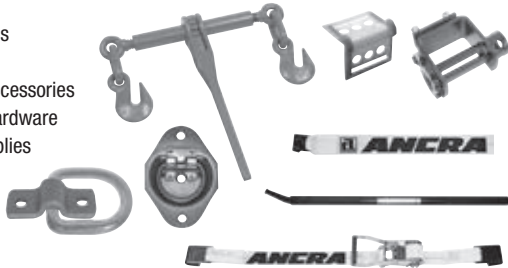

TRAILER REPAIR

- Refrigerated Trailer Wall Repair Patches
- Trailer Wall Repair Sealer*
- Trailer Repair Tape
- Fiberglass Repair Patches
- Aluminum Repair Patches
- Refrigerated Trailer Wall Emergency Repair Kits

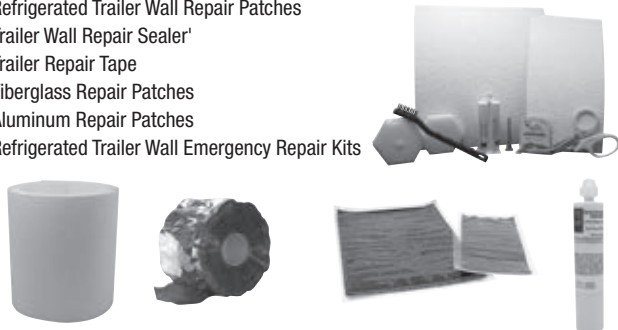

ADHESIVE LETTERS & NUMBERS

- Numbers
 - » Numerals: 0-9
 - » Sizes: 1", 1.25", 2", 3", 5"
 - » Colors: Black, White, Red, Blue
- Letters
 - » Letters: A-Z
 - » Sizes: 2" and 3"
 - » Colors: Black, White, Red



WIPER BLADES

- Imperial Crown™ Wiper Blades perform as well or better than other national brands and cost less.
 - » Imperial Crown™ HPB Series
 - » Imperial Crown™ Premium Series
 - » Imperial Crown™ Beam Series
 - » Imperial Crown™ Winter Series
- Other Brands Available
 - » Trico®
 - » Anco



SNOW & ICE REMOVAL

- Snow Brushes
- Snow Rakes



EXHAUST HARDWARE

- Preform Band Clamps
- Flat Band Clamps
- Turbo V-Band Clamps
- Muffler Clamps
- Flex Pipe
- Swinger Exhaust Hanger

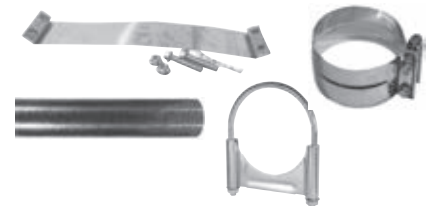

POWER TRANSMISSION

- Ball Joints
- Ratio Drive Parts
- Rod Ends
- Shaft Collars



Order before 1:00 CST for
same-day shipping.

Vehicle & Trailer Parts

VEHICLE INTERIOR

- Cab Fans
- Device Mounts
- Power Distribution
- Steering Wheel Covers
- Vehicle Seat Covers
- Vehicle Floor Mats
- Mattress Cover
- Seatbelt Covers



HEAT CONTROL

- Heat Barrier Sheet
- Heat Barrier Tape
- Sound Insulation
- High Temp Adhesive



KEY CONTROL & IDENTIFICATION

- Key Duplicators & Accessories
- Key Cutters & Accessories
- Key Codes
- Key Blanks
- Key Cabinets
- Key Lubricants
- Key Tags
- Key Rings
- Key Tag Identification

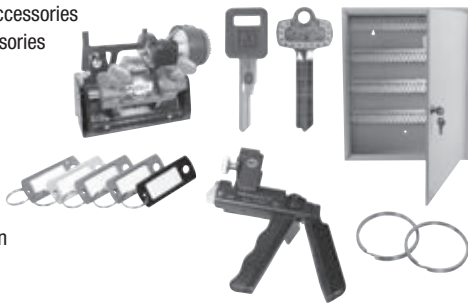

BRAKE MAINTENANCE

- Lathe Bits
- Lathe Silencers
- Brake Lathe Tool
- Brake Lathe Silencer Bands
- Brake Hub Cleaning Disc Kit

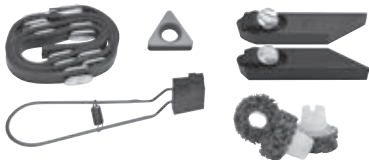

OIL MAINTENANCE

- Fluid Transfer
- Oil Drain Plugs
- Sealing Gaskets & Washers
- Oil Maintenance Accessories



MIRRORS

- Convex
- West Coast
- Heated Style
- Mirror Assemblies
- Stick-on
- Mirror Hardware



FUEL TANK ACCESSORIES

- Locking Fuel Caps
- Breather Caps
- Fuel Tank Repair Kits
- Anti-Siphons



TIRE & WHEEL

- Wheel Weights
 - » Zinc
 - » Steel
 - » Lead
 - » Adhesive
 - » Accessories
- Wheel Hardware
 - » Studs & Stud Bolts
 - » Wheel End Hardware
 - » Wheel Seals
 - » Wheel Nuts
 - » Bearing Buddies
 - » Wheel Hardware Accessories
- Tire Valve Caps
- Tire Valve Extensions
- Tire Valve Stems & Cores
- Tire Pressure Gauges
- Air Chucks
- Tire Inflators
- Tire Repair Tools
- Tire Markers
- Tire Thread Depth Gauges
- Tire Repair Chemicals
- Tire Patches
- Tire Mounting Chemicals
- Tire Mounting Tools



BODY CLIPS & HARDWARE

- Automotive Body & Alignment Shims
- Automotive Body Bolts
- Automotive Bumper Bolts
- Automotive Fuel & Engine Miscellaneous Clips
- Automotive Grommets & Inserts
- Automotive Harness
- Automotive Headlight Adjustment Screws
- Automotive Hood, Door & Body Panel Clips
- Automotive Nuts
- Automotive Plug Buttons
- Automotive Pushnuts
- Automotive Retainers
- Automotive Rivets
- Automotive Rocker Clips
- Automotive Rubber & Plastic Bumpers
- Automotive Screws
- Automotive Windshield & Glass Clips
- Automotive Wiring, Split Loom, & Cable Routing



Assortments

FASTENER ASSORTMENTS

BOLT ASSORTMENTS

Comes in 36, 40 and 72-hole bins or in steel parts drawer.

HEX HEAD CAP SCREWS, NUTS, FLAT WASHERS & LOCK WASHERS

- Grade 8 Hex Head Cap Screws
 - » Coarse Thread
 - » Fine Thread
 - » Coarse & Fine Combined
- Grade 5 Hex Head Cap Screws
 - » Coarse Thread
 - » Fine Thread
 - » Coarse & Fine Combined
- Metric Hex Head Cap Screws
 - » 8.8
 - » 10.9
- Stainless Steel Hex Head Cap Screws
 - » Fractional
 - » Metric



CARRIAGE BOLTS THREADED ROD

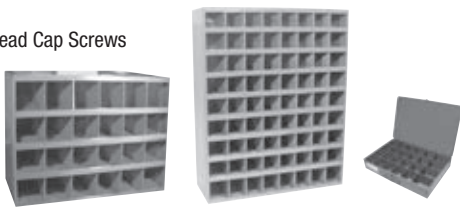

NUT ASSORTMENTS

Comes in a steel parts drawer.

- Grade 8 Hex Nuts
- Grade 8 Lock Nuts
- Grade B Prevailing Torque Lock Nuts
- Nylon Insert Lock Nuts
- Metal & Nylon Lock Insert Nuts
- Wing Nuts



WASHER ASSORTMENTS

Comes in a steel parts drawer.

- Thick Fender Washers
- Thin Fender Washers
- Star Washers

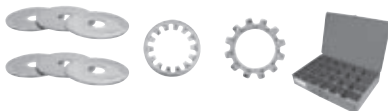

SCREW ASSORTMENTS

Comes in a steel parts drawer.

- Set Screws
- Machine Screws
- Trim Screws
- Thread Cutting Screws
- Sheet Metal Screws



CUTTING TOOL ASSORTMENTS

DRILL BIT INDEXES & CENTERS

Comes in a steel drill case.

- Mechanics Length Drill Bits
- Jobber Length Drill Bits
- Silver & Deming Drill Bits
- Left Hand Drill Bits

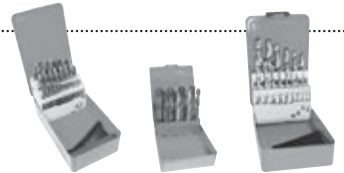

REAMER ASSORTMENTS

Comes in a steel parts drawer.

- Includes Reamers, Center Drills, & Cutting Oil Spray.



RECIPROCATING BLADE ASSORTMENTS

Comes in a steel parts drawer.

- Teeth per inch of 10, 14, 18, & 24
- Lengths include: 4", 6" & 8"



VEHICLE LIGHTING ASSORTMENTS

REPLACEMENT BULB ASSORTMENTS

Comes in a steel parts cabinet or steel bin.

- Variety of miniature bulbs.

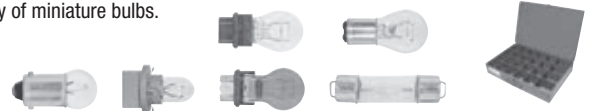

SHOP SUPPLIES ASSORTMENTS

GREASE FITTING ASSORTMENTS

Comes in plastic container or steel parts drawer.

- Grease Fittings
- Heavy-Duty Grease Fittings
- Metric Grease Fittings



VEHICLE PARTS ASSORTMENTS

VEHICLE PARTS ASSORTMENTS

Comes in a steel parts drawer.

- Trim Retainers
- Wheel Studs
- Oil Drain Plugs & Gaskets
- Adhesive Numbers & Letters



Assortments

ELECTRICAL ASSORTMENTS

CABLE TIE ASSORTMENTS

Comes in a steel parts drawer.

- Black Nylon Cable Ties
- White & Black Cable Ties
- Colored Cable Ties



ELECTRICAL TERMINAL ASSORTMENTS

Comes in a steel parts drawer.

- Heat Shrink Electrical Terminals
- Nylon Electrical Terminals
- Vinyl Electrical Terminals
- Twist Connectors



HEAT SHRINK TUBING ASSORTMENTS

Comes in a steel parts drawer.

- Seal-A-Splice® Heat Shrink Tubing
- Polyolefin Thinwall Heat Shrink Tubing
- Flexible MW Heat Shrink



ELECTRICAL CONNECTION SYSTEM ASSORTMENTS

Comes in a steel parts drawer.

- Weather Pack Connectors
- Metri-Pack Connectors
- Deutsch Connectors



PRIMARY WIRE ASSORTMENTS

Comes in a primary wire organizer rack

- Cross Link Primary Wire
- Thermoplastic Primary Wire

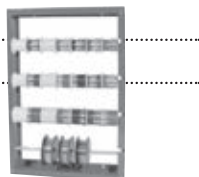

FUSE ASSORTMENTS

Comes in a steel parts drawer.

- ATM, Mini & Maxi Fuses
- ATO/ATC Fuse Kit
- Mini Fuse Kit
- ATM Fuse Kit
- ATO Fuse Kit
- Blo & Glo® Fuses
- Glass Fuses



BATTERY TERMINAL ASSORTMENTS

Comes in a steel parts drawer.

- 31 Series Battery Terminals
- Top Post Battery Terminals
- Copper Lugs
- Battery Tools



AIR BRAKE ASSORTMENTS

AIR BRAKE ASSORTMENTS

Comes in a steel parts drawer.

- Compression Air Brake Fittings For Air Brake Tubing (DOT)
- Push-To-Connect Air Brake Fittings for Air Brake Tubing (DOT)
- Compression Air Brake Fittings for Copper Tubing (DOT)
- Compression Fittings for Transmission Air Lines (Not DOT Approved)



TUBE & TUBE FITTING ASSORTMENTS

TUBE & TUBE FITTING ASSORTMENTS

Comes in a steel parts drawer or 64-Drawer Cabinet

- Brass Pipe Fittings
- Flared Fittings
- Compression Tube Fittings
- Heavy-Duty Black Iron Pipe Fittings
- Caps & Plugs

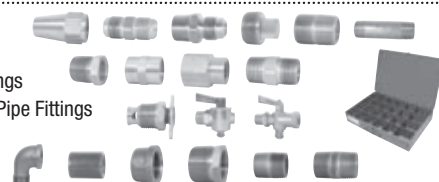

HOSE & HOSE END ASSORTMENTS

HOSE & HOSE END ASSORTMENTS

Comes in a steel parts drawer.

- Vacuum Fittings
- Male Fuel Fittings
- Shop Air Hose Repair Kit
- Barb-Tite Hose Fittings
- Heater Hose Splice Kit
- Air Brake Emergency Kit



ABRASIVE ASSORTMENTS

SURFACE CONDITIONING & SANDING ASSORT.

Comes in a steel parts drawer.

- Quick Connect Surface Conditioning Discs
 - » 2" and 3" diameters
 - » Coarse and Medium Grits
- R-Style Disc Holders

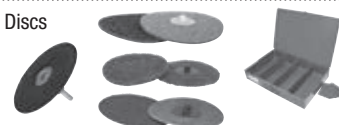

RIVET ASSORTMENTS

RIVET ASSORTMENTS

Comes in a steel parts drawer.

- Drive Rivets
- Blind Rivets
- Multi-Range Rivets

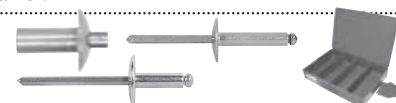

Assortments

HARDWARE ASSORTMENTS

THREADED INSERT ASSORTMENTS

Comes in a steel parts drawer.

- Heavy-Duty Thread Repair
- Thinwall Thread Repair
- Nutserts
- Flange Knurl Nutserts



O-RING ASSORTMENTS

Comes in a steel parts drawer.

- Boss O-rings
- Small Diameter O-rings
- Large Diameter O-rings



RETAINING CLIP ASSORTMENTS

Comes in a steel parts drawer.

- E-clips Retaining Rings
- Internal/External Snap Rings



EXPANSION PLUG ASSORTMENTS

Comes in a steel parts drawer.

- Cup Type Steel Expansion Plugs



HOSE CLAMP ASSORTMENTS

Includes a hose clamp rack or steel parts drawer

- Standard Hose Clamps
- Large Hose Clamps
- Lined Hose Clamps
- Large Lined Hose Clamps
- All Stainless Steel Hose Clamps
- Shrink Clamps
- Vinyl Tube Clamps

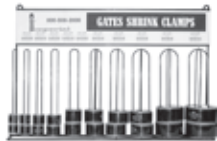

PIN ASSORTMENTS

Comes in a steel parts drawer.

- Cotter Pins
- Hairpin Cotter Pins & Clips
- Universal Clevis Pins
- Roll Pins
- Compression Springs
- Extension Springs

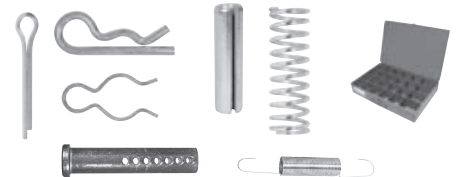

GROMMET ASSORTMENTS

Comes in a steel parts drawer.

- Firewall Grommets

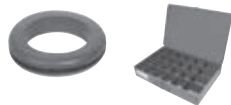

KEYSTOCK ASSORTMENTS

Comes in a steel parts drawer.

- Square Key Stock
- Woodruff Keys



SHOP ORGANIZATION IS THE KEY TO EFFICIENT MAINTENANCE AND REPAIR.

- Imperial offers a complete line of storage bins, drawers, and racks to help you organize your parts department.
- Pre-packaged product assortments to meet your every need.
- Easy, quick retrieval.
- Eliminate the guesswork with parts storage.
- Visual inventory control.
- Heavy gauge steel construction.
- Bins, drawers, racks, stands, and cabinets are also available separately.
- Plastic shelf bins and stackable bins are also available.

Steel Equipment & Storage

STEEL HOLE BINS & ACCESSORIES

- Bin Hole Configurations:
 - » 4-Hole Bin
 - » 20-Hole Bin
 - » 24-Hole Bin
 - » 36-Hole Bin
 - » 40-Hole Bin
 - » 42-Hole Bin
 - » 72-Hole Bin
- Bin Stands
- Bin Stand Legs
- Bin Topper

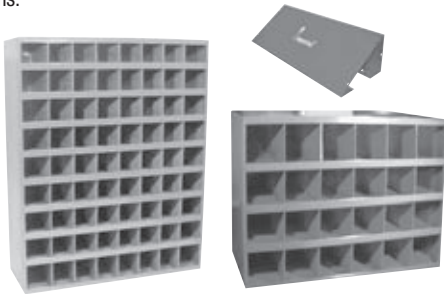

STEEL DRAWER RACKS & ACCESSORIES

- Drawer Racks
 - » 2-Drawer Rack with Ball Bearing Slides
 - » 4-Drawer Rack with Ball Bearing Slides
 - » 5-Drawer Rack
- Drawer Rack Stand
- Locking Hinges
- Rack Topper



STEEL DRAWERS & ACCESSORIES

- Steel Parts Drawers
 - » 6-Hole Fixed Compartments
 - » 24-Hole Fixed Compartments
 - » 16-Hole Fixed Compartments
 - » Adjustable Vertical/Horizontal Compartments
 - » Adjustable Horizontal Compartments, Fixed Vertical
- Plastic Parts Drawers
 - » 24-Hole Fixed Compartments
- Drawer Dividers
- Replacement Drawer Inserts

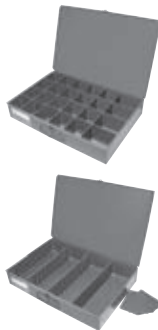

STEEL DRAWER CABINETS & ACCESSORIES

- Drawer Configurations
 - » 9-Drawer Cabinet
 - » 18-Drawer Cabinet
 - » 20-Drawer Cabinet
 - » 64-Drawer Cabinet
- Tilt Out Tray Cabinet
 - » Four Tilt Out Drawers
 - » 28 Plastic Drawer Dividers
- Drawer Cabinet Dividers

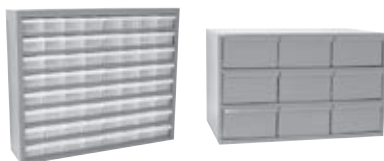

PLASTIC ORGANIZERS

- 12-Hole Fixed Compartment Large Plastic Case
- 6-Hole Adjustable Utility Parts Box
- 12 to 62-Hole Adjustable Lid Storage Organizer



PLASTIC PARTS STORAGE BAGS

- Reclosable Poly Bags
 - » 2 mil, 6" x 6"
 - » 4 mil, 12" x 12"
- Flat Polyethylene Bags
 - » 2 mil, 8" x 6"
 - » 2 mil, 12" x 18"

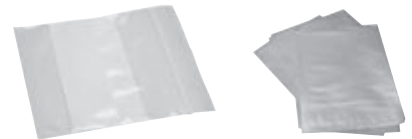

CORRUGATED CARDBOARD

- Corrugated Shelf Boxes
- Corrugated Shelf Box Dividers
- Corrugated Boxes

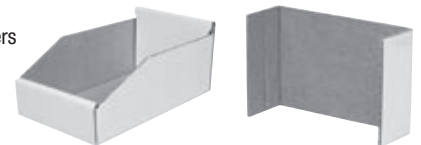

SHELF BINS & ACCESSORIES

- Plastic Shelf Bins
- Stackable Shelf Bins
- Single Sided Storage Bin
- Label Holders
- Bin Dividers
- Shelf Bin Racks

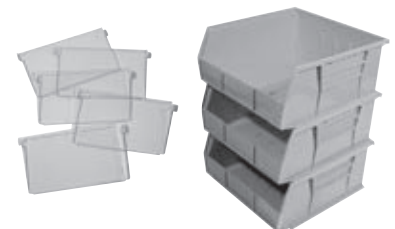

SPECIALTY STEEL STORAGE

- Hose Cabinets
- Welding Rod Cabinets
- Threaded Rod Cabinets
- Aerosol Can Cabinet
- Bulk Chemical Shelf and Drip Tray
- Air Brake Hose Assembly Rack
- Brake Line Rack
- Stock Cabinets
- Hose Clamp Wire Racks
- Jan
- Wire Organizer
- Wire Caddy
- Drill Bit Cabinet
- Battery Tool Carry Case
- Tubing Dispenser
- Wiper Blade Rack
- Floor Mat Dispenser
- Nitrile Glove Box Dispenser
- Key Cabinets

Call a Dedicated Service Advisor To Place an Order Today.

SUMMARY TERMS & CONDITIONS

Terms: By placing an order customers accept and agree to terms and conditions of Imperial Supplies, LLC ("Imperial"), the full text of which can be found at www.imperialsupplies.com.

Wholesale Only: Imperial sells products for business use to customers with proper business identification.

Prices: Prices listed are wholesale, do not include freight, handling fees, taxes, and/or duties, and are subject to correction or change without notice. Imperial reserves the right to accept or reject any order.

Sales Tax: Customers are responsible for payment of all applicable taxes, or providing a valid sales tax exemption certificate.

Shipping Charges: Products are shipped F.O.B. shipping point with costs and handling fees paid by Imperial and charged to customer. Orders over U.S. \$400 (including any backorders) are shipped freight free. C.O.D. shipments are not permitted. Other terms and conditions may apply for freight collect, special handling, or shipments outside the contiguous United States. Fuel surcharges may be applied. Title and risk of loss pass to customer upon shipment to carrier. Vendor drop-shipped products are excluded from our standard freight policy and the customer is responsible for freight on drop-ship products.

Payment Terms: Imperial accepts cash, checks, money orders, Visa, MasterCard, and American Express. For customers with established Imperial credit, payment terms are one-half percent (1/2%) ten (10) days, net 30 days from the date of shipment. If payment is not received within the 30-day period, Imperial may defer or cancel all or part of any shipment or order.

Product Return: Product returns must be made within one year from date of purchase, unless otherwise indicated. Returned product must be in original packaging, unused, undamaged and in saleable condition. Proof of purchase is required.

Product Substitution: Products and country of origin may be substituted and may not be identical to Catalog or website published descriptions and/or images.

Other Products and Services: Orders for export and products and services not listed in this Catalog are subject to separate terms and conditions; see www.imperialsupplies.com.

IMPERIAL LIMITED WARRANTY

LIMITED WARRANTY: IMPERIAL WARRANTS PRODUCTS FOR A PERIOD OF ONE YEAR FROM THE DATE OF PURCHASE, UNLESS OTHERWISE STATED. PROVIDED THAT IMPERIAL ACCEPTS THE PRODUCT FOR RETURN, IMPERIAL MAY, AT ITS OPTION, REPAIR, REPLACE, OR REFUND THE AMOUNT PAID BY CUSTOMER. ALL OTHER WARRANTIES, EXPRESS OR IMPLIED, INCLUDING BUT NOT LIMITED TO THE IMPLIED WARRANTIES OF MERCHANTABILITY, FITNESS FOR A PARTICULAR PURPOSE OR NON-INFRINGEMENT OF INTELLECTUAL PROPERTY RIGHTS ARE SPECIFICALLY DISCLAIMED.

LIMITATION OF LIABILITY: IMPERIAL SHALL NOT BE LIABLE FOR CONSEQUENTIAL, INCIDENTAL, SPECIAL, EXEMPLARY, OR PUNITIVE DAMAGES. IMPERIAL'S LIABILITY, IN ALL CIRCUMSTANCES, SHALL NOT EXCEED THE PURCHASE PRICE PAID FOR THE PRODUCT THAT GIVES RISE TO ANY LIABILITY.

Manufacturer's Warranty: For information on a particular manufacturer's warranty, please contact your assigned teleservicing agent.

Cancellation: All product order cancellations must be approved by Imperial, and may be subject to restocking fees and other charges.

A full statement of Imperial's terms and conditions is available on www.imperialsupplies.com and is incorporated by reference.

PRODUCT INFORMATION

Product information and Material Safety Data Sheets ("MSDS") are prepared and supplied by the manufacturers. IMPERIAL MAKES NO WARRANTIES AND EXPRESSLY DISCLAIMS ALL LIABILITY FOR ACCURACY OF THE INFORMATION IN ANY MSDS.

Send MSDS Requests to: (i) Imperial, PO Box 11008, Green Bay WI 54307-1008; or (ii) contact the teleservicing agent at 1-800-558-2808.

Product Compliance and Suitability: Imperial does not guarantee compliance or suitability of the products it sells with any laws, codes or regulations, nor does Imperial accept responsibility for construction, installation, and/or use of a product. Customer is solely responsible for reliance on or use of any product information, and for use or application of any product.

California Proposition 65: The State of California requires that certain warnings be given concerning products which contain chemicals subject to Proposition 65. For identification of products which contain chemicals subject to Proposition 65, go to www.imperialsupplies.com. Applicable Proposition 65 warning(s), see below, are provided upon product purchase.

Warning: This product contains a chemical known to the State of California to cause cancer.

Warning: This product contains a chemical known to the State of California to cause birth defects or other reproductive harm.

IMPERIAL ECOSAFE® PAINT CHART

Rainbow White #85165, 16 oz	Custom White #85145, 16 oz	Drop Box White #85159, 16 oz	Gloss White #85102, 16 oz #85002, 20 oz	Sandable White Primer #85211, 16 oz	Colonial White #85127, 16 oz	Flat Black #85110, 16 oz	Gloss Black #85101, 16 oz	Satin Black #85120, 16 oz
DD Silver #85150, 16 oz	Custom Gray #85049, 16 oz	PMT Gray #85039, 16 oz	Light Machine Gray #85017, 20 oz	Self-Etching Gray Primer #85018, 16 oz	Argent Gray Bumper #85117, 20 oz	Chrome Brite #85013, 16 oz	Light Trailer Gray #85072, 16 oz	
Gray Primer #85200, 20 oz	Light Gray Rim #85116, 20 oz	Sandable Gray Primer #85212, 16 oz	Gray Rim #85020, 20 oz	Dark Gray #85146, 16 oz	Dark Trailer Gray #85074, 16 oz	Lift Semi Gloss Gray #85095, 20 oz	Blue Gray #85147, 16 oz	
Universal Gray #85044, 16 oz	Nav Gray #85069, 16 oz	IHC Gray #85098, 20 oz	Medium Gray #85149, 16 oz	Dark Bumper Gray #85054, 16 oz	Drop Box Metallic Gray #85161, 16 oz			
Cream #85091, 16 oz	Biege #85092, 16 oz	Tractor Beige #85143, 16 oz	Power Tan #85096, 20 oz	SW Gold #85126, 16 oz	Dark Brown #85142, 16 oz			
New Yellow #85207, 20 oz	Gloss Yellow #85005, 20 oz, #85105, 16 oz	WM Safety Tail Yellow #85135, 16 oz	Bright Yellow #85141, 16 oz	Leasing Yellow #85180, 16 oz	School Bus Yellow #85151, 16 oz	Dynamic Yellow #85158, 16 oz	Forklift Yellow #85097, 20 oz	Equipment Yellow #85153, 16 oz
Swamp Holly Orange #85070, 16 oz	Construction Orange #85045, 16 oz	Omaha Orange #85077, 16 oz	JCT Orange #85014, 16 oz	Universal Orange #85208, 20 oz	Road Omaha Orange #85053, 16 oz	Orange #85154, 16 oz	Drop Box Orange #85162, 16 oz	Lift Orange #85119, 16 oz
C.C. Red #85008, 20 oz	Tractor Red #85056, 16 oz	Gloss Red #85003, 20 oz, #85103, 16 oz	Primer Red Oxide #85202, 20 oz	Burgundy #85148, 16 oz				
Teal Green #85089, 20 oz	Equipment Green #85094, 20 oz	Alpine Green #85144, 16 oz	SB Green #85028, 20 oz	Blue Green #85021, 20 oz	Dark Green #85128, 16 oz	Medium Green #85171, 16 oz	Forest Green #85166, 16 oz	
Leasing Blue #85210, 20 oz	MC Blue #85048, 16 oz	True Blue #85205, 20 oz	Gloss Blue #85004, 20 oz, #85104, 16 oz	Bright Blue #85209, 20 oz	Rainbow Blue #85114, 20 oz	URS Blue #85157, 16 oz	GW Blue #85052, 16 oz	
Royal Blue #85167, 16 oz	Canyon Blue #85140, 16 oz	Midnight Blue #85115, 20 oz	Dark Blue #85198, 16 oz	FL Blue #85152, 16 oz	Drop Box Purple #85160, 16 oz			

DON'T SEE THE COLOR YOU NEED?

We can custom match your color! Give Imperial a call today. Minimum quantities required.

Ounces listed are can size. Due to printing limitations colors may not be exact representations of paint.

FASTENERS

Bolts

Carriage Bolts
Elevator Bolts
Eye Bolts
Flange Bolts
Hex Head Cap Screws
Grade 5
Grade 8
Stainless Steel
Metric/Fractional
J-Bolts
Plow Bolts
Spring Center Bolts
Step Bolts
Tap Bolts
Threaded Rod
U-Bolts

Nuts

Flange Nuts
Hex Nuts
Lock Nuts
Specialty Nuts

Screws

Deck Screws
Drywall Screws
Floorboard Screws
Lag Screws
License Plate Screws
Machine Screws
Self-Drilling Screws
Set Screws
Sheet Metal Screws
Socket Cap Screws
Thread Cutting Screws
Thumb Screws
Trim Screws
Wood Screws

Washers

Fender Washers
Flat Washers
Lock Washers
Machinery Bushings
Nylon Washers
Rib Spring Washers
Rivet Back-Up Washers
Sealing Washers
Structural Washers
Trim Washers

HARDWARE

Anchors
Cable & Cable Accessories
Chains & Chain Accessories
Grommets
Hog Rings
Hose Clamps & Clips
Key Stock
O-Rings
Pins
Pipe Hanging Strap
Retaining Rings
Rope
Snap Bolts & Hooks
Snap Fasteners
Springs
Thread Inserts
Tie Wire & Lock Wire
Yoke Ends

RIVETS & RIVET TOOLS

Blind Rivets
Drive Rivets
Multi-Grip Rivets
Panel Fasteners
Pin & Collar Rivets
Rivet Tools
Semi-Tubular Rivets
Solid Rivets
Structural Rivets

VEHICLE LIGHTING

Vehicle Lighting Brands
Imperial
Truck-Lite
Grote
Peterson
Betts
Back Up Lamps
Clearance/Marker Lamps
Conspicuity Tape
Directional Lamps
Dome Lights
Front/Park/Turn Lamps
Forward Lighting
Grommets
License Plate Lamps
Lighting Accessories
Mini Bulbs
Mounting Accessories
Multi-Function Lamps
Pigtails
Reflectors

Replacement Lens & Covers
Signal Lamps
Stop/Tail/Turn Lamps
Strobe Lights
Utility Lamps
Work Lamps

ELECTRICAL

Back Up Alarms
Battery Supplies
Battery Accessories
Battery Cable
Battery Cable Tools
Battery Connectors
Battery Harnesses
Solder Slugs
Booster Packs & Jumper Cables
Cable Ties
Circuit Breakers
Cords
7-Way ABS Cords
ISO Cords
Lift Gate Cords
Non-ABS Cords
Coaxial Cable & Connectors
Electrical Connection Systems
Deutsch Connectors
Metri-Pack Connectors
Micro-Pack Connectors
Weather Pack Connectors
Electrical Connectors
Electrical Terminals
Crimp, Solder & Seal Terminals
Heat Shrink Terminals
Non-Insulated Terminals
Nylon Terminals
Solder Seal Terminals
Special Application Terminals
Vinyl Terminals
Electrical Wire
Flashers
Fuses
Gauges
Heat Shrink Tubing
Horns
Pigtails & Harnesses
Power & Air Brake Cord
Relays
Switches
Test Instruments
Wire Management
Cable Ties & Cable Tie Mounts
Loom & Spiral Wrap
Wire Marking Labels

TUBING & TUBE FITTINGS

Brake Lines & Fittings
Bulkhead Fittings
Caps & Plugs
Compression Fittings
Flared Fittings
Mini Barbed Fittings
Pipe Fittings
Tubing
Tubing & Tube Fitting Tools
Valves

AIR BRAKE

Air Brake Accessories
Air Brake Assemblies
DOT Air Brake Fittings for Air Brake Tubing
DOT Air Brake Fittings for Copper Tubing
DOT Air Brake Fittings for Rubber Hose
DOT Air Brake Tubing
DOT Rubber Air Brake Hose
Glad Hands & Glad Hand Seals
Transmission Line Fittings (Non DOT)

HOSE & HOSE ENDS

Barbed Fittings
Couplers
Hose
Coolant Hose
Fuel Hose
General Purpose Hose
High Pressure Hose
Medium Pressure Hose
PTFE Hose
Refrigerant Hose
Suction Hose
Truck Hydraulic Hose
Vacuum Hose
Hose Accessories
Hose Ends
Crimp Hose Ends
EZ-Clip System
Reusable/Field Attachable Hose Ends
Hydraulic Crimping Components
Vacuum Connectors

CUTTING TOOLS

Countersinks
Drill Bit Index Sets & Centers
Drill Bit Sharpening
Drill Bits

Drill Tools & Accessories
Extractors
Hacksaws & Hacksaw Blades
Hole Expansion Bits
Hole Saws
Saw Blades
Taps & Dies
Utility Knives, Scrapers & Blades

ABRASIVES

Band & Roll Abrasives
Carbide Roll Abrasives
Expanding Drums
Flap Bands
Spiral Bands Abrasives
Spiral Point Abrasives
Bristle Discs
Carbide Burrs
Cut-Off Blades & Wheels
Decal Removal
Flap Wheels & Discs
Grinding Wheels
Hand Abrasives
Mounted Points
Sanding Discs
Sheet & Roll Abrasives
Stripping & Removal Discs
Surface Conditioning
Wire Abrasives
Cup Brushes
End Brushes
Tube Brushes
Wire Wheel Brushes

SAFETY

Emergency Eye Wash Equipment
Ergonomics
Eye Protection
Face Protection
Fire Protection
First Aid
Hand Protection
Head Protection
Hearing Protection
Hydration
Identification Products
Lockout Devices
Respirators
Safety Storage
Signs
Slip & Fall Protection
Spill Control
Traffic Safety
Workwear

PAINT & PAINT SUPPLIES

Grease Markers
Marking Paints
Paint Brushes & Rollers
Paint Pens & Markers
Painting Supplies
Spray Paints & Primers
Stencil Ink
Striping & Marking Applicators
Touch-Up Paints

CHEMICALS

Chemicals

Additives
Air Tool Chemicals
Anti-Seize
Brake Lubricants
Brake Parts Cleaner
Caulking & Sealers
Coil Cleaners
Cutting Oils
De-Icers
Degreasers & Cleaners
Dielectric Grease
Electrical Protectors & Cleaners
Gasket Makers & Sealants
Glues & Cements
Greases
Insecticides
Leak Sealers & Gap Fillers
Lubricants
RTV Silicones
Rubberized Undercoat & Panel Coat
Rust Protectors & Converters
Specialty Chemicals
Spray Adhesives
Structural Adhesives
Thread Sealants
Threadlockers
Vehicle Adhesives & Sealers
Windshield Adhesives & Primers

Dispensing

Bulk Containers & Nozzles
Dilution Dispensing Systems
Spray Bottles & Triggers
Steel Applicators & Accessories

SHOP SUPPLIES

Batteries
Document Management
Drum & Barrel Pumps
Electrical Boxes & Receptacles
Extension Cords
Hand Tools
Hand Cleaners & Dispensers
Hand Sanitizer
Leak Detection
Lighting
Flashlights
Fluorescent Bulbs
Rough Service Bulbs
Trouble Lights
Work Lights
Lubrication
Grease Couplers
Grease Fittings
Grease Guns
Grease Hoses
Maintenance Tools
Parts Washing
Pneumatics
Power Tools
Shop Air Hose
Tape
Thermal Paper
Tool Boxes & Tool Storage
Vehicle Cleaning & Appearance
Vehicle Lifting Tools
Washing
Welding Supplies

JANITORIAL

Cleaning Supplies
Janitorial Chemicals
Odor Control
Paper Products
Personal Care
Shop Towels & Wipes
Trash Bags & Liners

VEHICLE & TRAILER PARTS

Trailer Parts & Accessories

Adhesive Numbers & Letters
Dock Bumpers
Document Holders
Door Hardware
Junction Boxes
Load Control
Stencil Numbers & Letters
Trailer Repair Supplies

Vehicle Parts & Accessories

Body Clips & Hardware
Brake Maintenance
Exhaust Hardware
Fuel Tank Accessories
Key Control & Identification
Key Blanks
Key Cabinets
Key Codes
Key Cutters & Duplicators
Key Rings & Tags

Mirrors

Oil Maintenance
Power Transmission
Snow & Ice Removal
Tire & Wheel
Air Chucks
Tire Inflators
Tire Measuring
Tire Mounting
Tire Repair
Tire Pressure Gauges
Tire Repair Patches & Plugs
Tire Repair Tools
Tire Valve Caps & Extensions
Tire Valve Stems & Cores
Wheel Hardware
Wheel Weights
Vehicle Accessories
Vehicle Interior
Wiper Blades

ASSORTMENTS

Abrasive Assortments
Air Brake Assortments
Body Clips & Hardware Assortments
Electrical Assortments
Fastener Assortments
Hardware Assortments
Hose End Assortments
Rivet Assortments

STEEL EQUIPMENT & STORAGE

Parts Organizers
Plastic Parts Storage Bags
Shelf Bins
Steel Drawer Cabinets
Steel Drawer Racks
Steel Hole Bins
Steel Parts Drawers
Steel Storage